

Owner's Manual

MOBILE THEATER

In Dash DVD Player, AM/FM, TV with CD Changer Control
and Motorized 7" Wide TFT LCD Display



Lanza[®]

STDIN70

www.lanza.com



Thank you for choosing the ~~~~~.

- Before using this product, read the instructions in the user's manual carefully.
- After reading it, keep the manual for future reference.



Table of contents

Table of contents3
 Cautions4
 Discs5
 Playable discs5
 TV color system5
 DVD Region code6
 Cautions on handling discs6
 Handling discs6
 Cleaning discs6
 Storing discs7
 Parts names and functions7
 When the LCD panel is closed7
 When the LCD panel is opened10
 Display12
 Remote controller12
 Basic operation15
 Powering on/off15
 Selecting the source15
 Adjusting the volume15
 Muting the sound16
 Checking the display status16
 Opening/Closing the LCD panel16
 Adjusting the angle of the LCD panel17
 Adjusting the extension distance of the LCD panel17
 Flattening the LCD panel17
 Turning on/off the LCD monitor18
 Using the touch-screen18
 Replacing the batteries18
 Playback19

Using radio19
 Using TV22
 Playing DVD source25
 DVD video playback25
 Audio CD playback28
 MP3 disc playback29
 Video CD playback31
 Using CD changer33
 Using external input35
 Using NAVI36
 Advanced operation38
 Main setup38
 Sound setup41
 DVD setup45
 Other setup52
 ZONE setup55
 Adjusting touch sensitivity of the LCD panel57
 Installing CAR Navigation58
 Appendix62
 DVD player error messages62
 Troubleshooting62
 Specifications65
 Installation66
 System connection72
 Power connection73
 PTY List74
 H/W I/F Specifications of Car Navigation Supported
 by the Product75

Cautions

Danger

- For your safety, do not watch DVD or TV or operate the product while driving. Doing so could lead to accidents. In some countries or states, watching DVD or TV while driving may be against law.
- For your safety, do not set the volume too high. Doing so could lead to accidents.

Warning

- Do not disassemble, repair, or modify the product. Doing so could cause the product to malfunction or be damaged. This could in turn void the warranty and violate FCC Rules.
- If you need to park the vehicle outdoors for an extended period of time, make sure the panel is returned into the main unit. Otherwise, the panel could be damaged.
- Do not let beverages or umbrellas get the product wet. Doing so could damage the product.
- Do not force the LCD panel out or place anything on the back of the LCD panel when it is extended. Doing so could damage the LCD panel.
- Do not allow anything to impact the LCD panel. Doing so could damage the LCD panel.
- Be careful not to touch the LCD panel with a lighted cigarette. Doing so could damage the LCD panel.

- When adjusting the tilt of the LCD panel, make sure nothing is jammed between the LCD panel and the main unit to avoid damaging the product.
- Do not expose the remote controller to direct sunlight. Doing so could cause the remote controller to malfunction.
- Do not press too hard on the casing surrounding the touch panel. Doing so could cause the product to malfunction or be damaged.
- If you turn on the heater when the temperature inside the vehicle is low, wait for a while before starting to use the product. Otherwise, ice could appear on the disc surface or the optical lens, causing the product to malfunction or be damaged.
- Do not use the product in too cold an environment. Doing so could cause the LCD panel to temporarily slow down or pause, or become dark.
- If moisture appears on the disc surface, dry the surface with a soft cloth before using.
- If ice appears on the optical lens, be sure to dry the lens before using.
- Do not look directly into the disc insertion slot as the laser from the optical lens could damage your eyesight.
- Do not use this product while driving on unpaved roads that generate severe vibration. Doing so could cause the product to malfunction or damage the optical lens.
- Do not apply lubricants to the rotating partst of the product. Doing so could cause the unit to malfunction or be damaged.

Caution

- You may experience poor TV picture quality or noise in certain areas, for example inside a tunnel or in the basement of a building.
- You may experience poor picture quality or noise in such areas, for example inside a tunnel or in the basement of a building.
- You may experience poor picture quality or noise as a result of external factors such as subway power lines, high-voltage power lines, and signal equipment.
- You may experience interference with wireless communication if the product is not installed or used according to the instructions in the user's manual.
- You may experience interference with wireless communication if certain equipment is being used near the product.
- Do not clean the product with chemicals such as benzene, thinners, or acetone. Doing so could the paint to peel, or damage the product.
- Make sure the disc insertion slot is not blocked.

Discs

■ **Playable discs**

DVD Video discs



Single or double-sided discs

DVD video recorded on DVD-R, DVD-RW, DVD+R, or DVD+RW discs



Audio CD and MP3 files CD recorded on CD-R, CD-RW discs



VCD

Dolby Digital



■ **TV color system**

The DVD player can play discs of NTSC or PAL type only. It cannot play SECAM discs.

■ DVD Region code

The DVD video system assigns a region number to DVD video players and DVD discs according to the region where they are sold. For example, DVD video players sold in the United States can only play discs with the correct region number ('1', 'ALL', or any combination of numbers including '1'). The DVD region number is indicated on the disc jacket as shown below.



For more information on the region code by country, refer to the user's manual that comes with DVD titles.

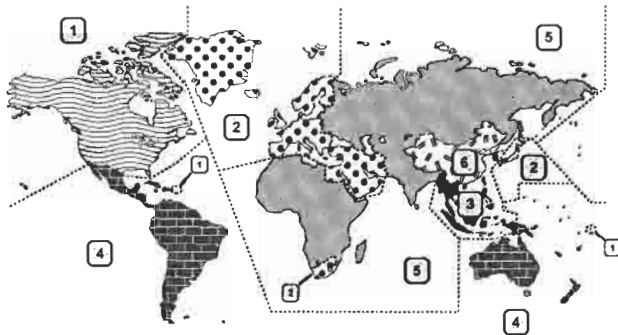

Cautions on handling discs

■ Handling discs

- Do not use discs with rough edges. Using such discs could cause the product to malfunction or be damaged.
- Do not attach labels to the disc surface or mark it with a pencil or pen. Doing so could cause the product to malfunction or be damaged.
- Do not use discs if they have scotch tape or other adhesive materials or traces of such material on them. Using such discs could cause the product to malfunction or be damaged.
- Do not use discs that are badly scratched, deformed or cracked. Using such discs could cause the product to malfunction or be damaged.
- Do not use commercially available CD protectors or disc stabilizers. Doing so could cause the product to malfunction or be damaged.
- Do not touch the disc surface when inserting or removing the disc.

■ Cleaning discs

- Use a soft cloth to wipe the disc from the center out towards the circumference.
- Do not use commercially available cleaners or static-proof sprays, or thinners on the disc. Doing so could damage the disc.

■ Storing discs

- Do not keep discs in places where it is too hot or cold. Doing so could deform them. Using deformed discs could cause the product to malfunction or be damaged.
- Do not keep discs in places exposed to direct sunlight or close to heaters. Doing so could deform the discs. Using deformed discs could cause the product to malfunction or be damaged.
- Do not keep discs in places that are too dusty or humid. Using discs stored in such places could cause the product to malfunction or be damaged.

Part names and functions

■ When the LCD panel is closed

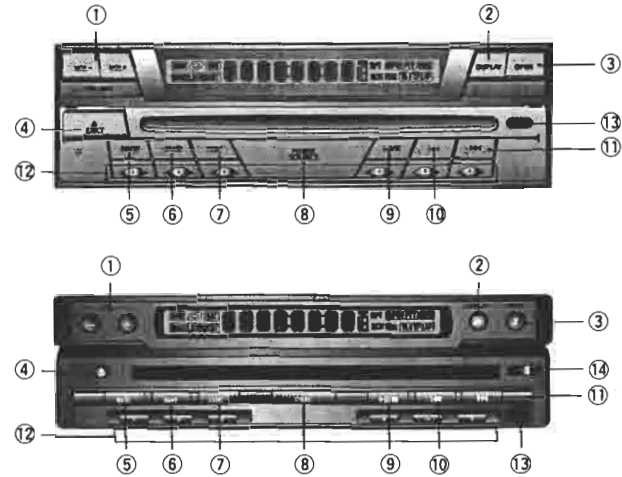

① [VOL] button

Press to adjust the volume.

② [DISPLAY] button

Press to switch between playback status and the clock on the display.

③ [OPEN] button

Press to open or close the LCD panel.

④ [EJECT] button

Press to remove the disc.

⑤ [MUTE] button

Press to mute the sound.
Press again to enable sound.

⑥ [BAND] button

Press to switch between reception bands for radio/TV/external input source.

- Radio: FM1 → FM2 → FM3 → AM1(MW) → AM2(LW)
- TV(Model with a TV Tuner): TV1 → TV2
- External input: AV1 → AV2 (CAM)*1 → (AV3)*2
 - *1 ETC - EXTERN - AV2 MODE in SETUP: CAM is displayed when REAR CAM is ON.
 - *2 ETC - EXTERN - AV3 MODE in SETUP: The NAVI source, not AV3, is displayed in EXTERN BAND when NAVI is ON.
- CD changer: Go to the next disc

When the source is radio or TV, press and hold the [BAND] button to switch between AUTO and MANUAL channel search modes.

⑦ [FUNC] button

Press to tune in the preset radio station regardless of the current source.

If the source is radio, press and hold the [FUNC] button to save the current radio station to the button.

Note:

For RDS-supported models, pressing the [FUNC] button will enable or disable the TA feature regardless of the source. Pressing and holding the [FUNC] button will enable or disable the AF feature.

⑧ [POWER/SOURCE] button

When the power is off, press the button to power on the unit.

When the power is on, press and hold the button for one second or longer to power it off.

To switch between sources, press the [POWER/SOURCE] button.

* Source changing sequence:

Radio → (TV)*1 → DVD → (CD changer)*2 → (NAVI)*3
→ EXTERN

*1 The TV source is only displayed in models with a TV tuner.

*2 The CD Changer source is only displayed if a CD changer is installed.

*3 The NAVI source is displayed only if ETC - EXTERN - AV3 MODE in SETUP is set to NAVI ON.

Note:

- You can switch to CD changer only if you have one installed.
- With the power off, insert a CD or DVD disc, and the unit will automatically power on and play the disc.
- When the LCD panel is closed, open the LCD panel, and the unit will automatically power on.



⑨ [▶||■] button

- Pressing the button will automatically activate the scanning of saved preset channels when the source is radio or TV.
- Press and hold the button when the source is radio or TV, and stations/channels will be automatically scanned and saved to presets.
- Press the button to play/pause the CD/DVD/CD changer. Press and hold it to stop playback.

⑩ [◀◀] button

- Radio/TV: Press to go to the previous station/channel.
- CD/CD changer: Press to go to the previous track.
- CD/DVD: Press to go to the previous track/chapter. When the button is being pressed, the reverse high playback speed changes in the following sequence.
* 2x → 4x → 8x → 32x

⑪ [▶▶] button

- Radio/TV: Press to go to the next station/channel.
- CD/DVD: Press to go to the next track/chapter. When the button is being pressed, the reverse high playback speed changes in the following sequence.
* 2x → 4x → 8x → 32x

⑫ [PRESET] button (1-6)

- Press to switch between preset stations.
- When the source is radio or TV, press and hold the preset button to save the current station to the preset button's number.

⑬ Remote controller's receiver

Receives signals from the remote controller.

Note:

The location of the remote controller receiver may vary depending on the product model.

⑭ [RELEASE] button (Available in some models)

Press to remove the front panel from the main unit to protect against theft.

■ When the LCD panel is opened

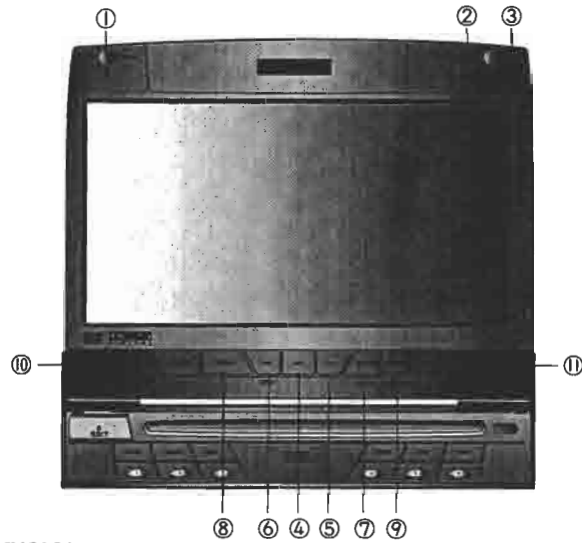

① [VOL] button

Press to adjust the volume.

② [DISPLAY] button

Press and hold the [DISPLAY] button to turn the LCD panel on or off.
 When the source is DVD, press the button to change display modes.

- DVD Video: Total Elapse → Total Remain → Chapter Elapse → Chapter Remain → Display Off



• VCD, CD: Single Elapse → Single Remain → Total Elapse → Total Remain

③ [OPEN/CLOSE] button

Press to open or close the LCD panel.
 Press and hold the button to maintain the panel in a horizontal position. After 10 seconds in this position, the alarm will sound and the panel will start to fold upward. Press the [OPEN/CLOSE] button to fold the LCD panel upward.

Note:

Maintaining the panel horizontal will enable easy access to A/C or temperature controls.

④ [**⏮**] button

- Radio/TV: Press the button to go to the previous station/channel.
- CD/CD changer: Press the button to go to the previous track.
- CD/DVD: Press to go to the previous track/chapter. When the button is being pressed, the reverse high playback speed changes in the following sequence.
* 2x → 4x → 8x → 32x

⑤ [**⏭**] button

- Radio/TV: Press the button to go to the next station/channel.
- CD/CD changer: Press the button to go to the next track.
- CD/DVD: Press the button to go to the next track/chapter. When the button is being pressed, the reverse high playback speed changes in the following sequence.
* 2x → 4x → 8x → 32x

⑥ [**⏸**] button

- Pressing it will automatically activate the scanning of saved preset channels.
- When the source is CD/DVD/CD changer, press the button to play/pause. Press and hold the button to stop playback.
- When the source is radio or TV, press and hold the button and stations/channels will be automatically scanned and saved to presets.

⑦ [**SOUND**] button

Press to go to the sound setup in system setup. Press and hold the button to enable or disable the loud setting.

⑧ [**SETUP**] button

Press and hold it to switch to the system setup screen.

⑨ [**NAVI**] button

Press and release the [NAVI] button to enter NAVI mode. Press and release it again to exit NAVI mode.
Press and hold the [NAVI] button to temporarily disable voice navigation information service (only applied to navigation models supported by this Product). For more information, see page 44.

Note:

To enable the [NAVI] button, be sure to set NAVI to "On" in the system setup.

⑩ [**MENU**] button

- Press the button during DVD video playback to display the root menu.
- Press and hold the button during DVD video playback to display the title menu.
- Press and hold in the SETUP screen to display the LCD touch control screen.

⑪ [**TILT**] button

This button allows you to change the angle of the LCD panel.
Press and hold the button to adjust how far the LCD panel is extended.

■ Display

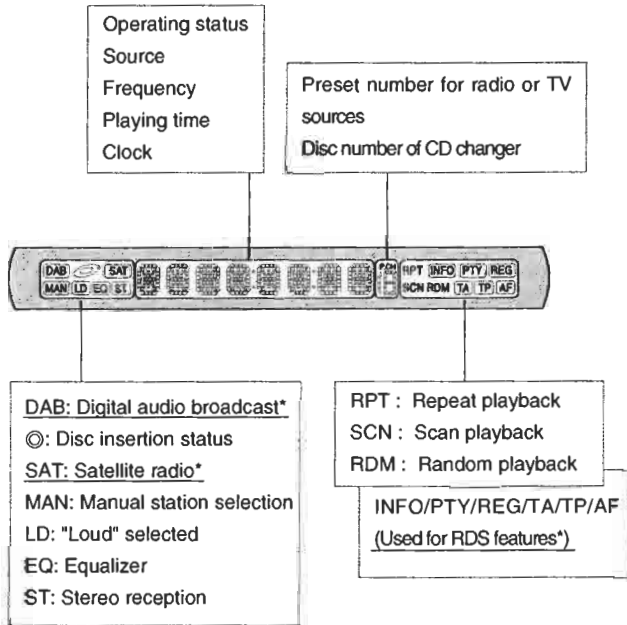

(* Indicates an optional feature, which will display only if the optional device is installed)

■ Remote controller

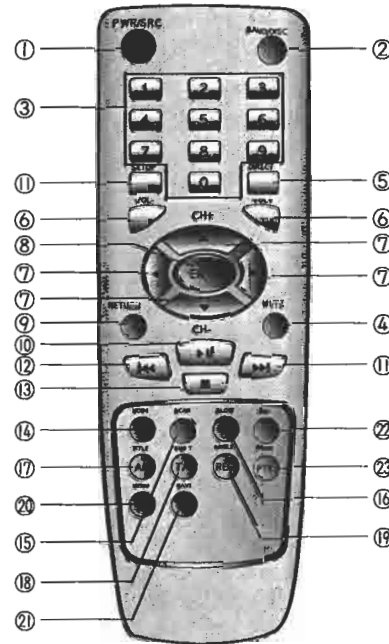

(* indicates an optional feature)



① **[POWER/SRC] button**

Functions the same as the [POWER/SRC] button on the main unit.

② **[BAND/DISC] button**

Functions the same as the [BAND/DISC] button on the main unit.

③ **[NUMBER KEYS] buttons**

- Radio/TV: Press to select from the channels saved in the preset numbers. Only buttons 1 to 6 are available.
- Radio/TV: Press and hold to save the current channel to the selected preset number. Only buttons 1 to 6 are available.
- DVD/CD/VCD/MP3: Press to go to and play the selected chapter/track number.

④ **[MUTE] button**

Press to mute the sound. Press it again to enable sound.

⑤ **[DIRECT] button**

Press during DVD, CD, MP3, and CDDA playback to display the numeric panel, where you can enter a number to go to the desired chapter or track.

⑥ **[VOLUME DOWN/UP] buttons**

Press to adjust the volume.

⑦ **[▲/▼/◀/▶] buttons**

- Radio/TV: Use the [▲/▼] buttons to increase or decrease the preset number.

- DVD/VCD playback: Use the [▲/▼] buttons to move the cursor on the screen.

- MP3 playback: Use the [▲/▼/◀/▶] buttons to move the track to play. Use the [◀/▶] buttons to move a page up and down the play list.

⑧ **[ENTER] button**

Press to confirm the selection for each setting.

⑨ **[RETURN] button**

Press to return to the previous menu for each setting.

⑩ **[▶||] button(PLAY/PAUSE)**

Functions the same as the [▶||] button on the main unit.

⑪ **[▶▶] button**

Functions the same as the [▶▶] button on the main unit.

⑫ **[◀◀] button**

Functions the same as the [◀◀] button on the main unit.

⑬ **[■] button(STOP)**

Press to stop playing a CD/VCD/MP3/DVD disc. Press the [▶||] button again to resume the playback.

Press the button twice in succession and then press the [▶||] button, and the source will begin to play from the beginning.



⑭ **[MODE] button**

Press to change the DVD/CD/VCD playing mode in the following sequence:

- DVD: Disc All → Random → Normal → Repeat Chapter → Repeat Title
- CD/VCD: Disc All → Random → Normal → Repeat Track
- MP3 : Folder Repeat → Random → Normal → Repeat Track

⑮ **[SCAN] button**

- Press to play the first 10 seconds of each DVD/CD disc chapter/track.
- Use this button to search for the desired portion or track.
- MP3 discs do not support this feature.

⑯ **[SLOW] button**

Press to play the DVD disc at a slow speed.

Forward: Normal → Slow 2x → Slow 4x → Slow 8x → Slow 16x
Reverse: Normal → Slow 2x → Slow 4x → Slow 8x → Slow 16x

⑰ **[TITLE] button**

DVD: Press the button to go to the title menu.

Radio (FM): Press the button to enable or disable the AF feature.

⑱ **[SUB T] button**

DVD: Press the button to change chapters.

Radio: Press the button to enable or disable the TA feature. For any other source, press and hold the button to enable or disable the TA feature.

⑲ **[ANGLE] button**

Press the button to switch angles while playing DVD discs.

Radio (FM): Press the button to enable or disable the REG feature.

⑳ **[MENU] button**

- Press the button during DVD video playback to display the root menu.
- Press and hold the button during DVD video playback to display the title menu.
- When the menu is displayed, press the button to make it disappear.

㉑ **[NAVI] button**

Functions the same as the [NAVI] button on the LCD panel.

㉒ **[DISP] button**

Press to change display modes while playing DVD discs.

- DVD Video: Total Elapse → Total Remain → Chapter Elapse → Chapter Remain → Display Off
- VCD, CD: Single Elapse → Single Remain → Total Elapse → Total Remain

㉓ **[AUDIO] button**

DVD: Press the button to change audio playback methods.

Radio (FM): Press the button to display the PTY search menu. Use the up/down buttons and the ENT button to search PTY.

Note:

The AF, TA, REG, and PTY features are available for RDS-supported models only.

Basic operation

■ Powering on/off



- Use the product while the engine is running. Using the product for an extended period of time with the engine off could lead to vehicle battery discharge and prevent the vehicle from being started.
- When you start the engine, the product will return to the state immediately before the engine was stopped.

1. Press the [POWER/SOURCE] button.

The main unit and the initial screen will be lit up. The main unit remembers and runs the last source and settings.

Note:

If you power off the unit with a DVD disc in it and power it back on later, the DVD disc will automatically play from where it left off.

2. Press and hold the [POWER/SOURCE] button for one second or longer to power the unit off.

Note:

The buttons remain lit if night lighting (illumination) is selected.

■ Selecting the source

1. Press the [POWER/SOURCE] button to change sources.

The sources will change in the following sequence.

Radio → TV → DVD → CD changer → EXTERN

Note:

- You can switch to CD changer only if you have one installed.
- With the power off, insert a CD or DVD disc, and the unit will automatically power on and play the disc.
- Opening the LCD panel will automatically power on the unit.
- For the sequence of changing sources, refer to the [POWER/SOURCE] button descriptions on page 8.

■ Adjusting the volume

Press the [VOL] button.

- Press the '+' button to increase the volume.
- Press the '-' button to decrease the volume.

There are 32 volume levels available from 0 to 31.

Note:

If you power off the unit at Maximum Volume level (it sets the limit on the volume when the unit turns on) or higher and power it back on later, the volume level will be automatically adjusted to the Maximum Volume level.

Note:

- You can adjust the Maximum Volume level from "BEEP/VOLUME" at the setup menu.
- If you power off the unit at a volume level of 10 or higher and power it back on later, the volume level will be automatically adjusted to the maximum volume level of 10.



For safe driving, keep the volume to a level at which sound from the outside can be heard inside the vehicle.

■ **Muting the sound**

1. Press the [MUTE] button.

The sound will be muted, and the speaker icon on the screen will change to the MUTE icon.

2. Press the [MUTE] button again to enable sound.

Note:

If there is no sound while playing DVD or CD, check to see if the unit is in MUTE mode.

■ **Checking the display status**

When the LCD panel is closed, the display shows you the source and operating status of the main unit.

Press the [DISP] button to view the current source/operating status, and the current time.

* The RDS information is also displayed in RDS-supported models.

■ **Opening/Closing the LCD panel**



Caution

- When the LCD is in operation, be careful not to get your hand or fingers caught between the panel and the main unit or the dashboard.
- Do not force the LCD panel to move. Doing so could damage the product.

Press the [OPEN] button.

The LCD panel will be automatically extended and aligned to the last used position.

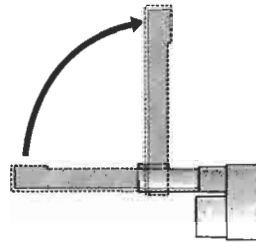

Note:

If the LCD panel stops moving or makes jammed sounds during operation, press the [OPEN] button again to place the panel back into its original position. Then [OPEN] button again.

■ **Adjusting the angle of the LCD panel**

The angle of the LCD panel is adjustable.

Press the [TILT] button.

With the 'beep' sound, the LCD panel can be adjusted up to 10 degrees forwards or backwards (20 degrees in total). When you open the LCD panel again, it will open to the last adjusted angle.

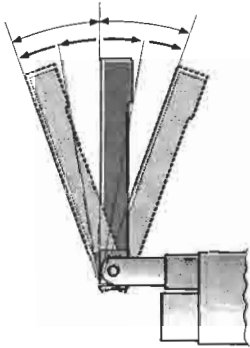

Caution

Do not force the LCD panel to move. Doing so could damage the product.

■ **Adjusting the extension distance of the LCD panel**

The extendable distance of the LCD panel can be adjusted.

Press and hold the [TILT] button.

Release the button after a 'beep' sound, and the LCD panel will move forward or backward. When you open the LCD panel again, it will move to the last adjusted position.

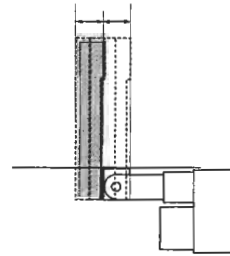

■ **Flattening the LCD panel**

If you need to use the buttons (the A/C button, for example) behind the LCD panel, you may temporarily flatten the panel for easy access to them.

1. With the LCD panel open, press the [OPEN] button until the 'beep- beep-' sound is heard.
2. The LCD panel folds horizontally.
3. Press the [OPEN] button.
The LCD folds vertically.

Note:

Even if the [OPEN] button is not pressed, the LCD panel will begin to fold vertically with the alarm sounding after 10 seconds have elapsed.

■ **Turning on/off the LCD monitor**

1. Press and hold the [NAVI] button for one second or longer.
The LCD monitor will turn on.
2. Press the [NAVI] button again.
The LCD monitor will turn off.

■ **Using the touch-screen**

Touch the icon on the screen to activate the function.
If the icons are not shown, tap on the LCD screen once to display them.

■ **Replacing the batteries**

1. Open the battery case cover of the remote controller by sliding it in the direction of the arrow.
2. Install two AAA (AM4 1.5V) batteries as shown in the figure.
3. Close the cover.

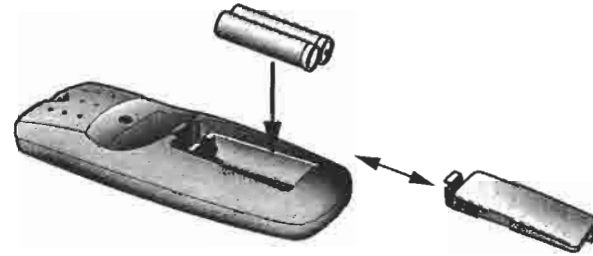

⚠ Danger

- Incorrect use of batteries may cause explosion.
- When replacing batteries, be sure to replace both of them with new ones.
- Do not heat up batteries or take them apart.
- Do not expose batteries to fire or flames.
- Remove the batteries from the remote controller when not in use for an extended period of time.
- Do not take batteries apart and throw them at persons or animals.
- Dispose of used batteries properly.

Playback

Using radio

Selecting radio

1. Press the POWER/SOURCE button on the main unit or the remote controller, or press the source icon on the LCD panel to select radio.
2. When you press the BAND button on the main unit, the BAND/DISC button on the remote controller, or the BAND icon on the LCD panel, the frequency band will switch between the following: FM1 → FM2 → FM3 → AM1 (MW) → AM2 (LW)

Screen configuration

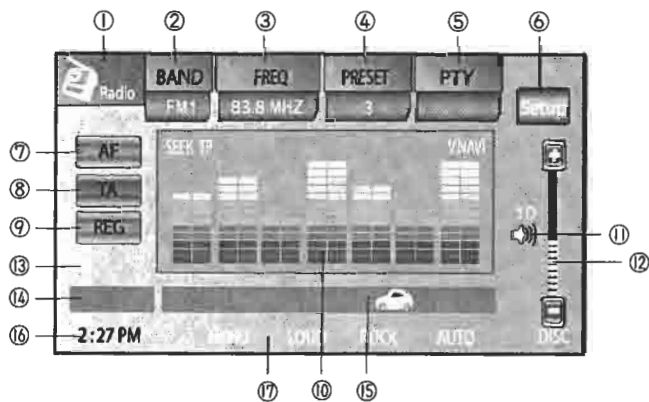

- ① Displays the active source. Press the icon to switch to the next source.
- ② Displays the active frequency band. Press the icon to switch between frequency bands: FM1, FM2, FM3, AM1 (MW), and AM2 (LW).
- ③ Displays the active station's frequency. Press the icon to display the frequency input screen. For more information on how to set the frequency, see "Frequency setup" on page 20.
- ④ Displays the preset number if a station is saved to the preset. Each time you press the icon, you will move to the station saved to the next preset number.
- ⑤ Press to display or not display the PTY** information. For more information on how to set PTY, see "PTY setup" on page 22.
- ⑥ Press to display the radio setup screen. For more information on how to set up radio, see "Radio setup screen" on page 21.
- ⑦ Press to enable or disable the AF** feature.
- ⑧ Press to enable or disable the TA** feature.
- ⑨ Press to enable or disable the REG** feature.
- ⑩ Displays the current sound status in EQ graphic format.
- ⑪ Press to enable or disable the mute feature. If mute is enabled, the icon will be changed to the mute icon.
- ⑫ Press to adjust the audio volume. Press the [+] or the [-] icon to turn the volume up or down.
- ⑬ Displays information about TP** or EON**.
- ⑭ Displays the name of the PS**.
- ⑮ Press the icon to display the RT** information.

- ⑩ Displays the current time if time display is enabled in user setup.
- ⑪ Displays the current audio setup or broadcast reception information.

Features marked with ** are available in RDS-supported models only. Non-RDS-supported models do not display the following icons:

- PTY (Program Type)
- AF (Alternate Frequency)
- TA (Traffic Announcement)
- REG (Regional)
- PS (Program Service)
- RT (Radio Text)
- TP (Traffic Program)
- EON (Enhanced Other Network)

Frequency setup

When the LCD panel is closed

1. Press the [◀] and/or [▶] button on the main unit to select the desired frequency.
2. If the preset is enabled, press a number button (1-6).

When the LCD panel is open, press the [FREQ] icon on the panel to display the numeric input pad.

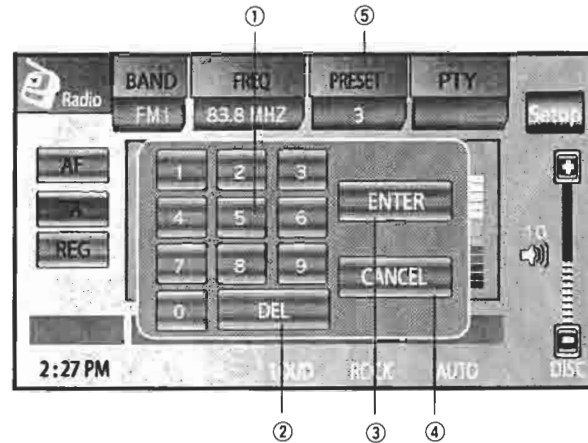

- ① Press to enter the numbers for the desired frequency.
- ② Press to delete the number entered.
- ③ Press to set the frequency entered.
- ④ Press to return to the previous screen without setting a frequency.
- ⑤ When the numeric input window appears, enter a valid frequency and press and hold PRESET. The frequency entered will be saved to the current PRESET number. The frequency entered will not be saved if it is not a valid one, or if there is no PRESET number available.

Note:

If no matching frequency is found, the panel will return to the previous screen without setting a frequency.

Radio setup screen

When the source is radio, press the 'Setup' icon to display the screen.

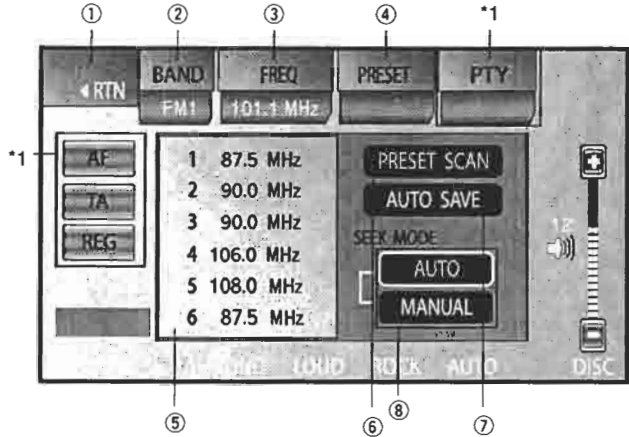

Note:
*1 icons are not displayed in models that do not support the *1 RDS feature.

- ① Press to return to the previous screen.
- ② Press to switch between frequency bands.
- ③ Press to display the frequency input screen.
- ④ Press to change the preset number.
- ⑤ Displays the status of preset scan and auto-save. Press the desired frequency on the LCD panel to move directly to that preset frequency.

To manually save a certain frequency to a preset, press the [FREQ] icon and enter the frequency. Or, press the [▶▶] and/or [◀◀] button to move to the desired frequency, and press and hold the preset button to which to save the frequency until the 'beep' sound is heard.

- ⑥ Press to listen to a preset broadcast briefly and move automatically to the next preset broadcast. To exit the process, press the [PRESET SCAN] icon again while preset scanning is in progress.
- ⑦ Press to scan the entire frequency range and save the scanned frequencies to preset memory. Six stations with the best reception conditions will be automatically selected and saved to the preset numbers. To exit the process, press the [AUTO SAVE] icon while auto saving is in progress.

Note:
If the AF or TA feature is enabled, only RDS stations will be saved.

- ⑧ Press to set station scanning to AUTO or MANUAL mode.

Note:

- If the AF feature is enabled, only RDS stations will be scanned.
- If the TA feature is enabled, only TP stations will be scanned.

[AUTO]: When the source is radio, press the [▶▶] button to automatically start to scan the next stations with higher frequencies. Press the [◀◀] button to automatically start to scan the next stations with lower frequencies.

[MANUAL]: When the source is radio, press the [▶▶] button to increase the frequency by one step. Press the [◀◀] button to decrease the frequency by one step.

How to set up presets

When the LCD panel is closed:

1. When the source is radio, press and hold the [▶||/■] button to automatically save the six stations/frequencies with the best reception conditions to preset memory.
2. Press the [▶||/■] button to automatically scan the saved preset memory.

When the LCD panel is open:

1. See the descriptions in "Radio setup screen" on page 21.

PTY setup

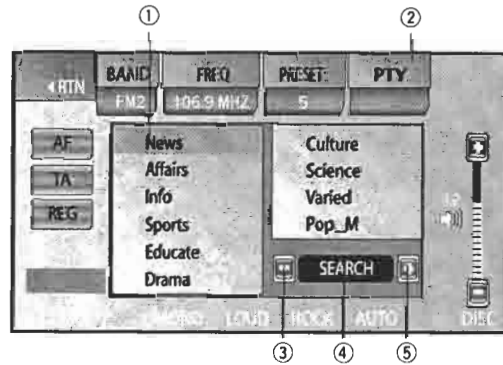

When the source is radio, press the [PTY] icon to display the following screen.

- ① Select and press the desired PTY.
- ② Displays the PTY of the found frequency. 'Not found' will be displayed if no matching PTY is found.
- ③ Press to go to the previous page.
- ④ Press to search for the frequencies of stations that match the selected PTY.
- ⑤ Press to go to the next page.

Note:

- The PTY feature is only applied to models that support RDS.
- There are a total of 29 PTYs available for selection, and they are listed on three pages. For more information on PTY, see "PTY List" on page 74.

■ **Using TV**

Only applied to models that support a TV tuner.

Selecting TV

1. Press the POWER/SOURCE button on the main unit or the remote controller, or the source icon on the LCD panel to select TV.
2. Each time you press the [BAND] button on the main unit, the [BAND/DISC] button on the remote controller, or the [BAND] icon on the LCD panel, the TV band will switch between TV1 and TV2.

Screen configuration

Tap on the LCD panel while receiving TV signals to display a screen where you can control the TV functions.

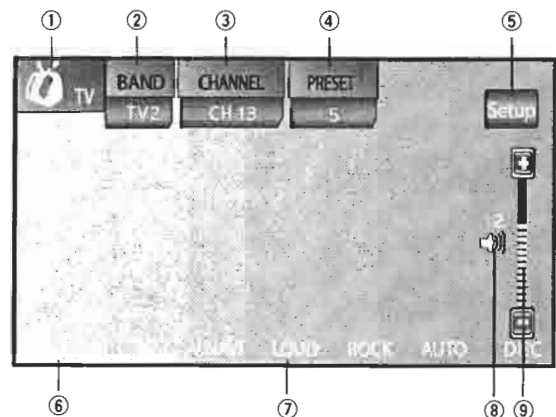

- ① Displays the active source. Press the icon to switch to the next source.
- ② Displays the active TV band. Press the icon to switch between TV1 and TV2.
- ③ Displays the active channel number. Press the icon to display the channel input screen. For more information on how to set up channels, see "Channel setup" on page 23.
- ④ Displays the preset number if stations are saved to preset numbers. Each time you press the icon, the station will switch to the station saved to the next preset number.

- ⑤ Press to display the TV setup screen. For more information on how to set up TV, see "TV setup screen" on page 24.
- ⑥ Displays the current time if time display is enabled in user setup.
- ⑦ Displays the current audio settings or broadcast information. TA will appear in models that support RDS. V.NAVI will appear only if you have installed a navigation system supported by this product, selected NAVI ON and set NAVI VOICE to ON in SETUP-ETC.

Note:
For how to set up NAVI VOICE, see "NAVI VOICE" on page 44.

- ⑧ Press to enable or disable the Mute feature. If Mute is enabled, the icon will change to the mute icon.
- ⑨ Press to adjust the audio volume. Press the [+]/[-] icon to turn the volume up/down.

Channel setup

When the LCD panel is closed:

1. Press the [◀◀] or the [▶▶] button on the main unit to select the desired channel.
2. If channels are saved to presets, press one of the number buttons (1-6) on the main unit or the remote controller.

When the LCD panel is open and the source is TV, press the [CHANNEL] icon to display the setup screen.

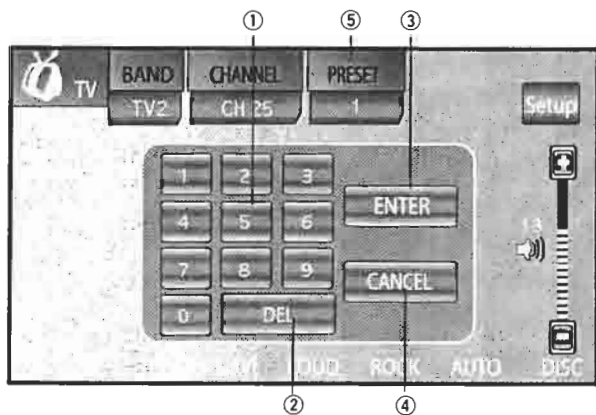

- ① Press to enter the desired channel.
- ② Press to delete the number entered.
- ③ Press to set the channel entered.
- ④ Press to return to the previous screen without setting a channel.
- ⑤ When the numeric input window appears, enter a valid frequency and press and hold PRESET.

The frequency entered will be saved to the current PRESET number.

The frequency entered will not be saved if it is not a valid one, or if there is no PRESET number available.

Note:

If no matching channel is found, the LCD panel returns to the previous screen without setting a channel.

TV setup screen

When the source is TV, press the [Setup] icon to display the screen.

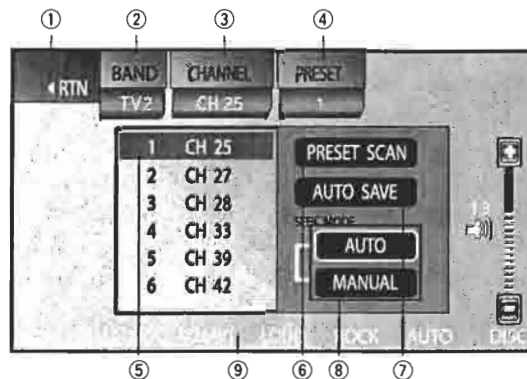

- ① Press to return to the previous screen without setting a channel.
- ② Press to switch between TV bands.
- ③ Press to display the channel input screen.
- ④ Press to change the preset number.
- ⑤ Displays the status of preset scan and auto-save. Press the desired channel on the LCD panel to move directly to that preset channel.
To manually save a certain channel number to a preset, press the [CHANNEL] icon and enter the channel. Or, press the [▶▶] or [◀◀] button to move to the desired channel, and press and hold the preset button to which to save the channel until the 'beep' sound is heard.
- ⑥ Press to listen to the preset broadcast briefly and move

automatically to the next preset broadcasting station. To exit the process, press the [PRESET SCAN] icon again while preset scanning is in progress.

- ⑦ Press to scan all channels in the TV band and save the scanned channels to preset memory. Six stations with the best reception conditions will be automatically selected and saved to preset numbers. To exit the process, press the [AUTO SAVE] icon while auto-saving is in progress.
- ⑧ Press to set station scanning to AUTO or MANUAL mode.
[AUTO]: When the source is TV, press the [▶▶] button to automatically start to scan the next stations with a higher channel number. Press the [◀◀] button to automatically start to scan the next stations with a lower channel number.
[MANUAL]: When the source is TV, press the [▶▶] button to move to the next higher channel. Press the [◀◀] button to move to the next lower channel.
- ⑨ TA will appear in models that support RDS. V.NAVI will appear only if you have installed a navigation system supported by this product, selected NAVI ON and set NAVI VOICE to ON in SETUP-ETC.

Note:

For how to set up NAVI VOICE, see "NAVI VOICE" on page 44.

How to set up presets

When the LCD panel is open:

1. When the source is TV, press and hold the [▶||/■] button to automatically save six stations/frequencies with the best

reception conditions to preset memory.

2. Press the [▶||/■] button to automatically scan the saved preset memory.

When the LCD panel is open:

- (1) See the descriptions in "TV setup screen" on page 24.

■ Playing DVD source

Selecting DVD source

1. Press the POWER/SOURCE button on the main unit or the remote controller, or the source icon on the LCD panel to select DVD.
2. When DVD is selected as source, a DVD disc, if already in the unit, will automatically begin to play. DVD video, CD, MP3, or VCD will be displayed as source depending on the disc that is being played.
3. If you insert a DVD disc when the source is not DVD, the source will automatically switch to DVD and the corresponding playback screen will be displayed.

Note:

If you select DVD as source but do not insert a disc within a certain period, the source will switch to radio.

■ DVD video playback

Screen configuration

If the source is DVD, tap on the LCD panel to display a screen where you can control the functions of the DVD player.

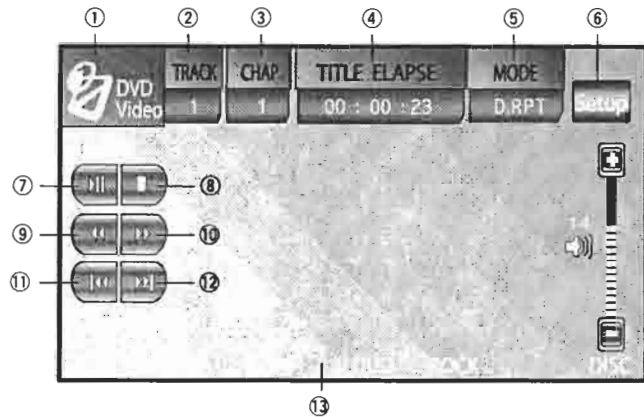

- ① Displays the active source. Press the icon to switch to the next source.
- ② Displays the number of the title that is being played. Press the icon to display the title input screen. For more information on how to set up title, see "Title, chapter setup" on page 27.
- ③ Displays the number of the chapter that is being played. Press the icon to display the chapter input screen. For more information on how to set up chapter, see "Title, chapter setup" on page 27.
- ④ Displays the playback time information. Press the icon to switch between playback time display modes.
 - TITL-ELAPSE: the current title's elapsed time
 - TITL-REMAIN: the current title's remaining time
 - CHAP-ELAPSE: the current chapter's elapsed time
 - CHAP-REMAIN: the current chapter's remaining time
- ⑤ Displays the disc playback mode. Press the icon to switch

between disc playback modes.

- D.RPT: repeat plays all the titles on the disc
 - RDM: plays all the titles on the disc in random order
 - NOR: plays consecutively from the chapter that is being played
 - RPT: repeat plays the chapter or title that is being played
- ⑥ Press to display the DVD setup screen. For more information on how to set up DVD, see "DVD setup screen" on page 27.
 - ⑦ Press to switch between play/pause modes.
 - ⑧ Press to stop playing. When it is stopped, press the [▶▶] icon to resume playing from where it stopped. Press the [■] icon twice in succession and then press the [▶▶] icon to play from the beginning.
 - ⑨ Press the [▶▶] icon during DVD playback for high-speed playback in the reverse direction. When you press the [▶▶] icon, the playback speed changes in the following sequence:
 - 2x → 4x → 8x → 32x → 1x (Forward playback)
 - ⑩ Press the icon during DVD playback for high-speed playback in the forward direction. When you press the icon, the playback speed changes in the following sequence:
 - 2x → 4x → 8x → 32x → 1x (Forward playback)
 - ⑪ Press to play from the beginning of the previous chapter.
 - ⑫ Press to play from the beginning of the next chapter.
 - ⑬ TA will appear in models that support RDS. V.NAVI will appear only if you have installed a navigation system supported by this product, selected NAVI ON and set NAVI VOICE to ON in SETUP-ETC.

Note:

For how to set up NAVI VOICE, see *NAVI VOICE* on page 44.

Title, chapter setup

When the source is DVD, press the [TITLE] or [CHAP] icon to display the following screen.

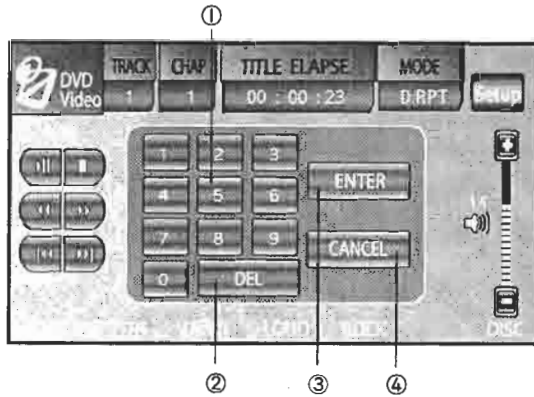

- ① Press to enter a title or chapter.
- ② Press to delete the number entered.
- ③ Press to set the title or chapter entered.
- ④ Press to return to the previous screen without setting a title or chapter.

Note:
If no matching title or chapter is found, the panel returns to the previous screen without setting a title or chapter.

DVD setup screen

When the source is DVD, press the [Setup] icon to display the screen.

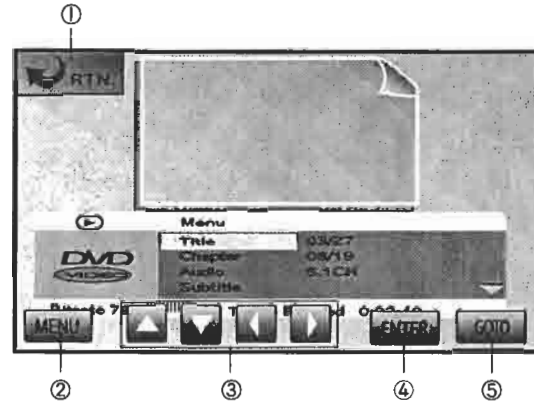

- ① Press to return to the previous screen.
- ② Press to move to the DVD disc root menu screen.
- ③ Press to move the cursor position.
- ④ Press to select the item where the cursor is located.
- ⑤ Press to move to the GOTO menu.

Note:

- The root menu screen and the GOTO menu may appear different depending on the DVD and the product version.
- In the root menu screen or the GOTO menu, use the [▲/▼/◀/▶], [ENTER] icons to view or change items as needed.

■ Audio CD Playing

When the source is audio CD, tap on the LCD panel to display a screen where you can control the functions of the audio CD player.

Screen configuration

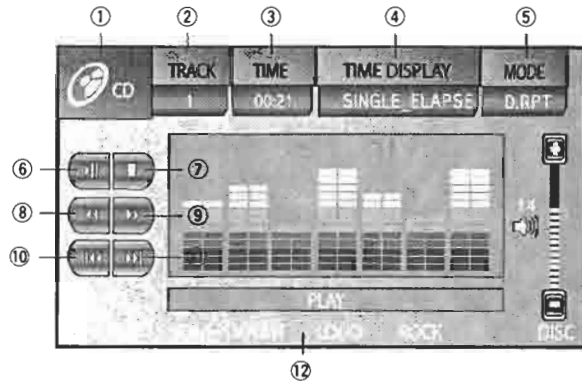

- ① Displays the active source. Press the icon to switch to the next source.
- ② Displays the number of the track that is being played. Press the icon to display the track input screen. For more information on how to set up track, see "Track setup" on page 29.
- ③ Displays the playback time information.
- ④ Press the icon to switch between playback time display modes.
 - SNGL-ELAPSE: the current track's elapsed time
 - SNGL-REMAIN: the current track's remaining time
 - TOTL-ELAPSE: the disc's total elapsed time

- TOTL-REMAIN: the disc's total remaining time
- ⑤ Displays the disc playback mode. Press the icon to switch between disc playback modes.
 - D.RPT: repeat plays all the tracks on the disc
 - RDM: plays all the tracks on the disc in random order
 - NOR: plays all the tracks consecutively
 - RPT: repeat plays the track that is being played
 - ⑥ Press to switch between play/pause modes.
 - ⑦ Press to stop playing. When it is stopped, press the [▶||] icon to resume playing from where it stopped. Press the [■] icon twice in succession and then press the [▶||] icon to play from the beginning.
 - ⑧ Press the [◀◀] icon during audio CD playback for high-speed playback in the reverse direction. When you press the [◀◀] icon, the playback speed changes in the following sequence:
 - 2x → 4x → 8x → 32x → 1x (Forward playback)
 - ⑨ Press the [▶▶] icon during audio CD playback for high-speed playback in the forward direction. When you press the [▶▶] icon, the playback speed changes in the following sequence:
 - 2x → 4x → 8x → 32x → 1x (Forward playback)
 - ⑩ Plays from the beginning of the current track if the current track has played for 10 seconds or longer. Plays from the beginning of the previous track, if the current track has played for less than 10 seconds.
 - ⑪ Press to play from the beginning of the next track.
 - ⑫ TA will appear in models that support RDS. V.NAVI will appear only if you have installed a navigation system supported by this product, selected NAVI ON and set NAVI VOICE to ON in SETUP-ETC.

Note:

For how to set up NAVI VOICE, see "NAVI VOICE" on page 44.

Track setup

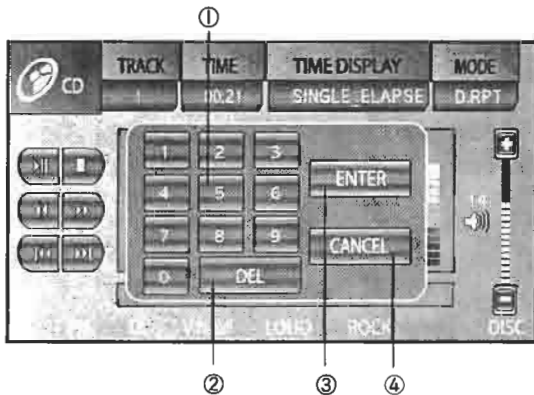

When the source is audio CD, press the [TRACK] icon to display the screen.

- ① Press to enter the number for the track to play.
- ② Press to delete the number entered.
- ③ Press to set the track entered.
- ④ Press to return to the previous screen without setting a track.

Note:

If no matching track is found, the panel will return to the previous screen without setting a track.

MP3 disc playback

When the source is MP3, tap on the LCD panel to display a screen where you can control the functions of the MP3 player.

Screen configuration

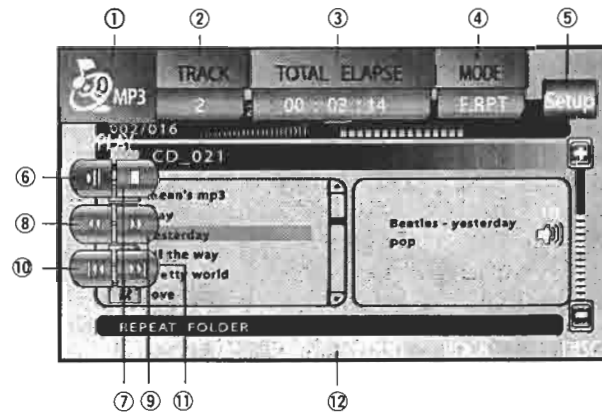

- ① Displays the active source. Press the icon to switch to the next source.
- ② Displays the number of the track that is being played. Press the icon to display the track input screen. For more information on how to set up track, see "Track setup" on page 30.
- ③ Displays the current track's elapsed time.
- ④ Displays the disc playback mode. Press the icon to switch between disc playback modes.
 - F.RPT : repeat plays all the tracks within the folder that is currently being played

- RDM: plays all the tracks within the folder that is being played in random order
 - NOR: plays all the tracks on the disc consecutively
 - RPT: repeat plays the track that is being played
- ⑤ Press to display the MP3 setup screen where you can select folders or files.
For more information on how to set up MP3, see "MP3 setup screen" on page 31.
 - ⑥ Press to switch between play/pause modes.
 - ⑦ Press to stop playing. When it is stopped, press the [▶] icon to resume playing from where it stopped.
Press the [▶] icon twice in succession and then press the [▶] icon to play from the beginning.
 - ⑧ Press the [◀◀] icon during MP3 playback for high-speed playback in the reverse direction. When you press the [◀◀] icon, the playback speed changes in the following sequence:
• 2x → 4x → 8x → 32x → 1x (Forward playback)
 - ⑨ Press the [▶▶] icon during MP3 playback for high-speed playback in the forward direction. When you press the [▶▶] icon, the playback speed changes in the following sequence:
• 2x → 4x → 8x → 32x → 1x (Forward playback)
 - ⑩ Plays from the beginning of the current track if the current track has played for 10 seconds or longer.
Plays from the beginning of the previous track if the current track has played for less than 10 seconds.
 - ⑪ Press to play from the beginning of the next track.
 - ⑫ TA will appear in models that support RDS. V.NAVI will appear only if you have installed a navigation system supported by this product, selected NAVI ON and set NAVI VOICE to ON in SETUP-ETC.

Note:

For how to set up NAVI VOICE, see "NAVI VOICE" on page 44.

Track setup

When the source is MP3, press the [TRACK] icon to display the following screen.

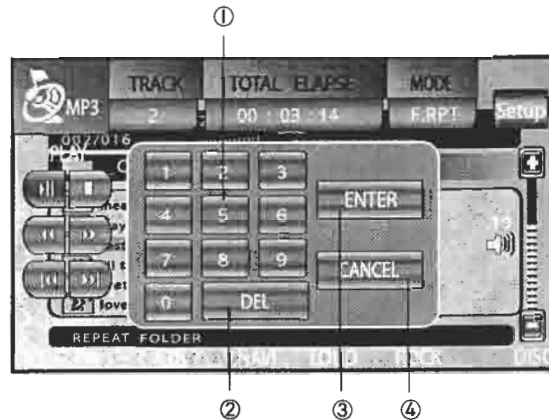

- ① Press to enter the number for the track to play.
- ② Press to delete the number entered.
- ③ Press to set the track entered.
- ④ Press to return to the previous screen without setting track.

Note:

If no matching track is found, the panel will return to the previous screen without setting a track.

press the Enter icon to play all the tracks beginning from the selected track.

Note:

If the number entered is greater than the number of tracks, the previous track will repeat playing.

MP3 setup screen

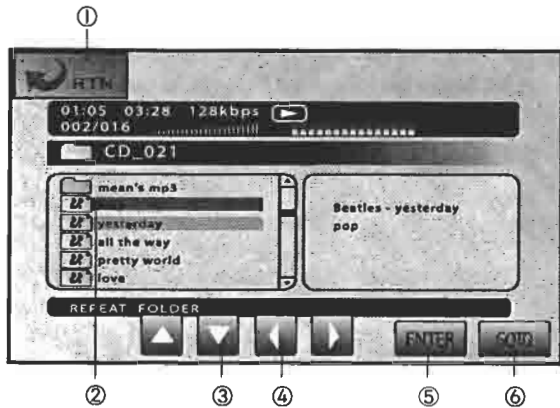

When the source is MP3, press the [Setup] icon to display the screen.

- ① Press to return to the previous screen.
- ② The blue cursor indicates the MP3 file that is being played.
- ③ Press to move the cursor up and down.
- ④ Press to move the cursor page up/down.
- ⑤ Press to enter the folder or play the file where the cursor is located.
- ⑥ Press to display the numeric input window. Enter a number and

■ **Video CD playback**

When the source is video CD, tap on the LCD panel to display a screen where you can control the functions of the video CD player.

Screen Configuration

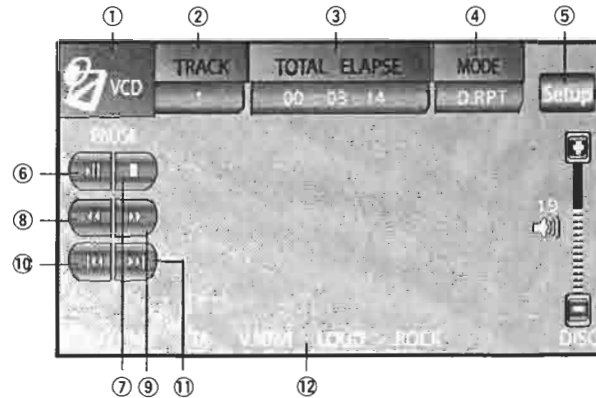

- ① Displays the active source. Press the icon to switch to the next source.

- ② Displays the number of the track that is being played. Press the icon to display the track input screen. For more information on how to set up track, see "Track setup" on page 32.
- ③ Displays the playback time information. Press the icon to switch between playback time display modes.
 - SINGLE-ELAPSE: the current track's elapsed time
 - SINGLE-REMAIN: the current track's remaining time
 - TOTAL-ELAPSE: the disc's total elapsed time
 - TOTAL-REMAIN: the disc's total remaining time
- ④ Displays the disc playback mode. Press the icon to switch between disc playback modes.
 - D.RPT: repeat plays all the tracks on the disc
 - RDM: plays all the tracks on the disc in random order
 - NOR: plays all the tracks on the disc consecutively
 - RPT: repeat plays the track that is being played
- ⑤ Press to display the VCD setup screen. For more information on the VCD set up, see "VCD setup screen" on page 33.
- ⑥ Press to switch between play/pause modes.
- ⑦ Press to stop playing. When it is stopped, press the [▶||] icon to resume playing from where it stopped. Press the [■] icon twice in succession and then press the [▶||] icon to play from the beginning.
- ⑧ Press the [◀◀] icon during video CD playback for high-speed playback in the reverse direction. When you press the [◀◀] icon, the playback speed changes in the following sequence:
 - 2x → 4x → 8x → 32x → 1x (Forward playback)
- ⑨ Press the [▶▶] icon during video CD playback for high-speed playback in the forward direction. When you press the [▶▶] icon, the playback speed changes in the following sequence:
 - 2x → 4x → 8x → 32x → 1x (Forward playback)

- ⑩ Plays from the beginning of the current track if the current track has played for 10 seconds or longer. Plays from the beginning of the previous track if the current track has played for less than 10 seconds.
- ⑪ Press to play from the beginning of the next track.
- ⑫ TA will appear in models that support RDS. V.NAVI will appear only if you have installed a navigation system supported by this product, selected NAVI ON and set NAVI VOICE to ON in SETUP-ETC.

Note:

For how to set up NAVI VOICE, see "NAVI VOICE" on page 44.

Track setup

When the source is video CD, press the [TRACK] icon to display the screen.

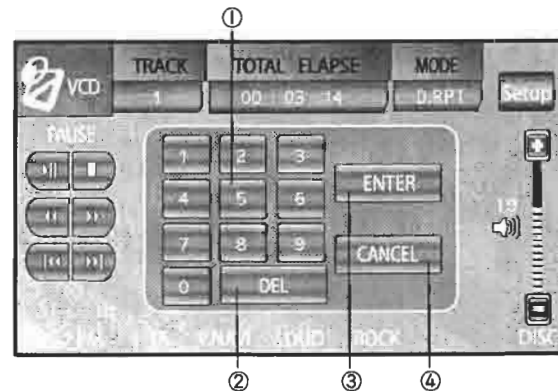

- ① Press to enter the number for the track to play.
- ② Press to delete the number entered.
- ③ Press to set the track entered.
- ④ Press to return to the previous screen without setting a track.

Note:

If no matching track is found, the panel will return to the previous screen without setting a track.

- ① Press to return to the previous screen.
- ② Press to move the cursor position.
- ③ Press to select the item where the cursor is located.

Note:

- The GOTO menu may appear different depending on the VCD and the product version.
- The GOTO menu allows you to use the [▲/▼/◀/▶], [ENTER] icons to view or change items as needed.

VCD setup screen

When the source is VCD, press the [Setup] icon and then the [GOTO] icon to display the screen.

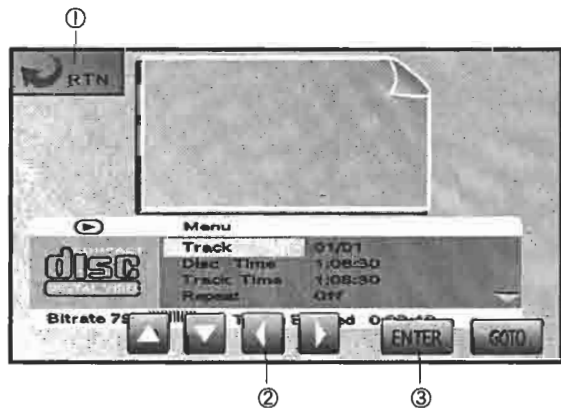

Using CD changer

When the source is CD changer, tap on the LCD panel to display a screen where you can control the functions of the CD changer.

Note:

You can only select CD changer as source if you have one installed.

Screen Configuration

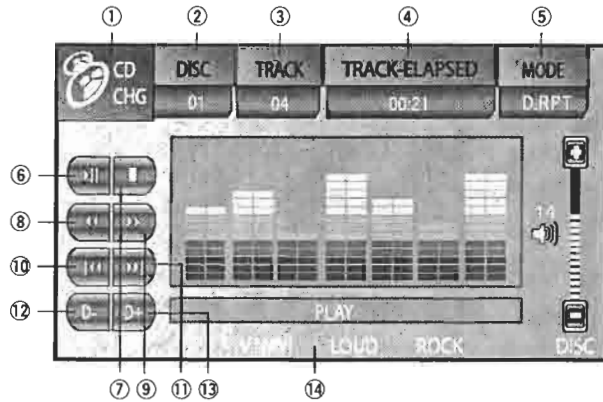

- ① Displays the active source. Press the icon to switch to the next source.
- ② Displays the number of the disc in the CD changer that is being played. Press the icon to display the disc number input screen. For more information on setup, see "CD changer, track setup" on page 35.
- ③ Displays the number of the track that is being played. Press the icon to display the track input screen. For more information on how to set up track, see "CD changer, track setup" on page 35.
- ④ Displays the playback time information.
- ⑤ Displays the disc playback mode. Press the icon to switch between disc playback modes.
 - RPT: repeat plays the track that is being played

- D.RPT: repeat plays all the tracks on the disc
 - RDM: plays all the tracks on the disc in random order
 - D.RDM: selects and plays discs and tracks in random order
 - SCAN: plays the first 10 seconds of every track on the current disc consecutively
 - D.SCAN: plays the first 10 seconds of every disc consecutively.
- ⑥ Press to switch between play/pause modes.
 - ⑦ Press to stop playing. When it is stopped, press the [▶||] icon to resume playing from where it stopped.
 - ⑧ Press the [◀◀] icon during CD changer playback for high-speed playback in the reverse direction. Each time you press the [◀◀] icon, the playback speed changes.
 - ⑨ Press the [▶▶] icon during CD changer playback for high-speed playback in the forward direction. Each time you press the [▶▶] icon, the playback speed changes.
 - ⑩ Plays from the beginning of the current track if the current track has played for 10 seconds or longer.
Plays from the beginning of the previous track if the current track has played for less than 10 seconds.
 - ⑪ Press to play from the beginning of the next track.
 - ⑫ Press to go to the previous disc in the CD changer.
 - ⑬ Press to go to the next disc in the CD changer.
 - ⑭ TA will appear in models that support RDS. V.NAVI will appear only if you have installed a navigation system supported by this product, selected NAVI ON and set NAVI VOICE to ON in SETUP-ETC.

Note:

For how to set up NAVI VOICE, see "NAVI VOICE" on page 44.

CD changer, track setup

When the source is CD changer, press the [DISC] or [TRACK] icon to display the following screen.

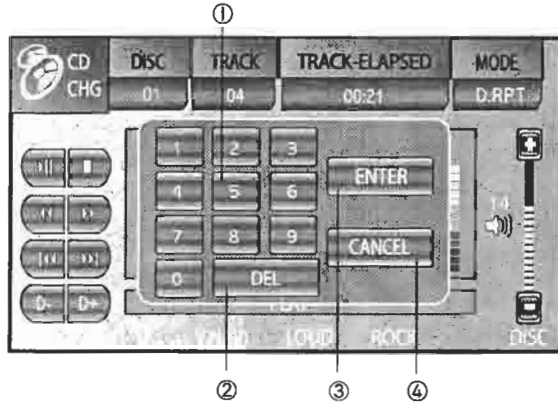

- ① Press to enter the disc or track to play.
- ② Press to delete the number entered.
- ③ Press to set the disc or track entered.
- ④ Press to return to the previous screen without setting disc or track.

Note:

If no matching track or disc is found, the panel will return to the previous screen without setting a track or disc.

Using external input

When the source is external input, tap on the LCD panel to display a screen where you control the functions of the external input.

Screen configuration

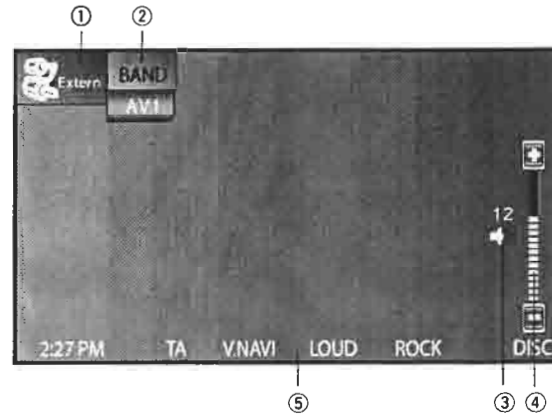

- ① Displays the active source. Press the icon to switch to the next source.
- ② Displays the name of the external input that is being played. Press the icon to switch to the next external input.
 - AV1: input Stereo Audio and CVBS Video signals.

- AV2: this is a terminal that connects to the rear camera; You can only input CVBS signals. You cannot input audio signals. If you set ETC - EXTERN - AV2 MODE in SETUP to REAR CAM ON, CAM, not AV2, is displayed. When the car is reversing, the rear camera input will be automatically detected and displayed on the CAM source screen.
- AV3: input RGB or CVBS Video and Mono Audio signals. If you use 13-pin NAVI cables, you can input stereo audio signals instead of mono audio signals. If you set ETC - EXTERN - AV3 MODE in SETUP to NAVI ON, the AV3 icon will be replaced by the NAVI icon as the external source.

Caution  The rear camera picture may not exactly reflect reality. Look around and make sure it is safe to reverse before doing so.

- ③ Press to enable or disable the Mute feature. If Mute is enabled, the  icon will change to the mute icon.
- ④ Press to adjust the audio volume. Press the [+]/[-] icon to turn the volume up/down.
- ⑤ TA will appear in models that support RDS. V.NAVI will appear only if you have installed a navigation system supported by this product, selected NAVI ON and set NAVI VOICE to ON in SETUP-ETC.

Note:
For how to set up NAVI VOICE, see "NAVI VOICE" on page 44.

■ Using NAVI

If you set ETC - EXTERN - AV3 MODE in SETUP to NAVI ON, the AV3 icon will be replaced by the NAVI icon as the external source. For information on how to install CAR navigation, see "Installing Car Navigation" in Advanced operation on page 58.

Screen Configuration

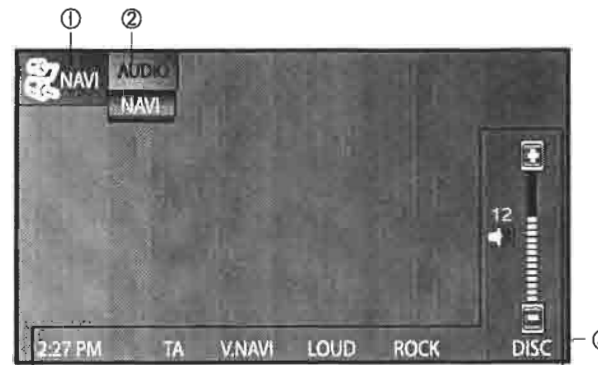

- ① The source currently being used is displayed. Pressing this icon will switch to the next source.
- ② The AUDIO source currently being played is displayed. Pressing this icon will switch to the next audio source. In other words, you can simultaneously listen to another AUDIO source while viewing the NAVI screen.
- ③ These icons will not appear if a navigation system supported by this product is installed.

Note

- **When Connecting to a Navigation System Supported by the Product**
 Use the dedicated 13-pin NAVI cable to connect navigation RGB signals and stereo audio.
 If you do this, you can listen to another audio source by pressing AUDIO in the NAVI screen.
 When audio output is from the navigation system, you can hear NAVI audio from the front L/R speakers.
- **When Connecting to a Navigation System Not Supported by the Product**
 Most CAR navigation systems use coaxial cables to connect RGB signals and mono audio, or CVBS and mono audio.
 In this case, If you set ETC - EXTERN - AV3 MODE in SETUP to NAVI ON, the AV3 will be replaced by the NAVI icon as the external source.
 You can use the [NAVI] button (See page 11) to switch instantly from other sources to the NAVI source.
 In the NAVI source screen, the AUDIO source is set as follows:
 - When you use the Source button or the Source icon on the screen to switch to the NAVI source, the NAVI screen and NAVI AUDIO source will be set.
 Once you switch to the NAVI source, the [NAVI] button will no longer work.
 To switch sources, press the NAVI source icon on the screen or press the [POWER/SOURCE] button.
 - When you press the [NAVI] button to directly switch to the NAVI screen, if the source is not NAVI, the NAVI screen and the previous AUDIO source will be set.
 Pressing the [NAVI] button again will take you directly to the previous source.
 In the NAVI screen, you can press the AUDIO icon to switch to the desired audio.
 - You can only listen to navigation audio output from the Front L/R speakers when the AUDIO source is set to NAVI.



Caution

For normal car navigation systems that do not use the dedicated 13-pin NAVI cable, you can press the AUDIO icon on the NAVI screen to select a different AUDIO source. You can listen to the navigation system's audio only when the AUDIO source on the NAVI screen is NAVI.

Note

Navigation products supported by the Product is the following:
 Korea: NSS-350M
 U.S.A., Europe: NSS-350D

Advanced operation

■ Main setup

Press and hold the [SETUP] button on the main unit for one second or longer, and then press the [MAIN] tab.

Note:

To exit the setup menu, press the [RTN] icon.

SCREEN

Adjust the contrast, tint, color, and brightness of the LCD panel.

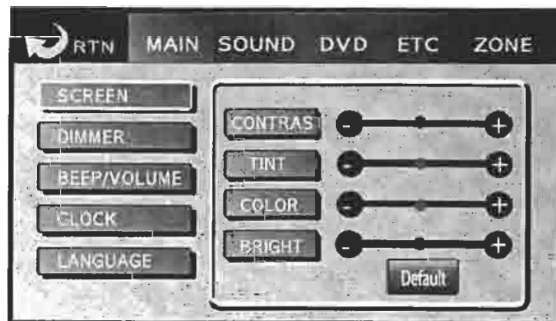

- CONTRAST: Press the [+] or [-] icons to adjust contrast.

- TINT: Press the [+] or [-] icons to adjust tint.
- COLOR: Press the [+] or [-] icons to adjust color.
- BRIGHT: Press the [+] or [-] icons to adjust brightness.

Note:

To reset to the factory settings, press the [Default] icon.

DIMMER

Dim or brighten the LCD panel according to the surrounding brightness.

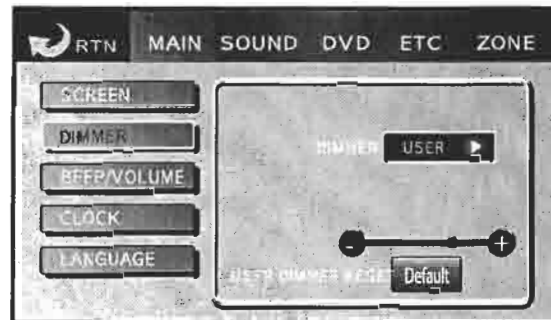

- DIMMER

Select either AUTO or USER mode.

- [AUTO]: The sensor attached to the main unit will automatically adjust the LCD panel brightness to the surrounding brightness.

- **[USER]:** Use the [+] or [-] icons to adjust brightness.

Note:
To reset to the factory settings, press the [Default] icon.

Caution  If DIMMER is set to 'AUTO' during nighttime driving, the brightness of the LCD panel may be affected by headlights from cars behind, and change constantly.

BEEP/VOLUME

Set up the beep sound and the maximum volume.



- **BEEP SOUND**

Turn the beep sound that is heard when pressing the touch panel on or off.

- ON: Beep is heard.
- OFF: No beep is heard.

- **MAXIMUM VOLUME**

Set the maximum volume. When the unit is turned on, the maximum volume setting is compared with the volume when the unit was last turned off. If the latter is greater than the former, the former will take effect, and vice versa.

- The maximum volume < The volume when the unit was turned off :
The maximum volume
- The maximum volume > The volume when the unit was turned off :
The volume when the unit was turned off

Caution  When you use the unit for the first time, be sure to set the maximum volume to a modest level.

CLOCK

Set up screen display, synchronization, 12H/24H time modes, and the current time.

- **TIME DISPLAY**

Set time display.

- ON: Time is displayed on the screen.
- OFF: Time is not displayed on the screen.

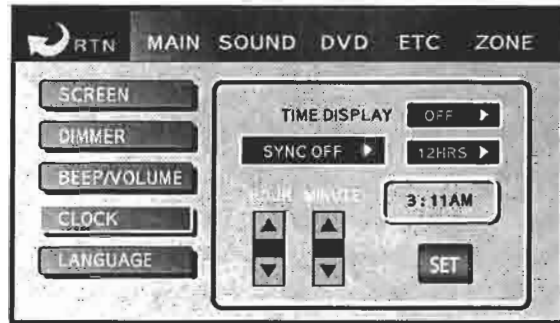

● **SYNC**

Synchronize with the broadcasting time provided in RDS regions.

- ON: Time is synchronized with the RDS broadcasting time.
- OFF: Time is set to the specified value.

Note:

SYNC will work only in models with the RDS feature.



Caution

- The clocks of the unit and of your car may be out of synchronization. Synchronize the two clocks.
- Setting this feature to ON may not immediately change the time.

● **TIME MODE**

Change the time display mode.

- 12H: The current time is displayed in 12H time mode. (AM, PM)
- 24H: The current time is displayed in 24H time mode.

● **TIME SET**

- HOUR: Set by pressing the [▲/▼] icons.
- MINUTE: Set by pressing the [▲/▼] icons.
- AM/PM: Set by pressing the AM or PM icon.

Note:

Displayed in 12H hour mode only.

- SET: Press the [SET] icon to save the set time.



Caution

- If you go to another menu or return to the previous screen without saving, changes will not take effect.
- The clocks of the unit and of your car may be out of synchronization. Synchronize the two clocks.

LANGUAGE

Set up the on-screen display (OSD) language.



- LANGUAGE
- LANGUAGE: Press  to select the desired language.
- SET: Press to set the language that has been selected.

Note:

The language you select here is applied to OSD only. The language of the disc itself (e.g. mp3 file names, DVD language) cannot be changed.

■ Sound setup

Press and hold the [SETUP] button on the main unit for one second or longer and then either press the [SOUND] tab, or press and release the [SOUND] button at the bottom of the monitor to display

the SOUND SETUP window.

The [NAVI VOICE] icon will be generated only if a navigation system supported by this product is installed, and AV3 MODE in SETUP-ETC-EXTERN is set to NAVI ON.

Note:

To exit the setup menu, press the [RTN] icon.

AUDIO CONTROL

Set up the volume of the left/right/front/rear speakers and various sound effects.

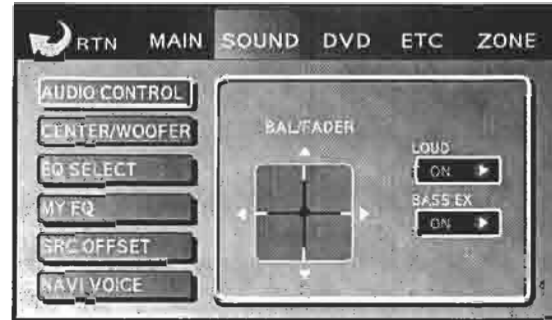

- BAL/FADER

Press the four arrow icons to adjust the volume of the left/right/front/rear speakers.

● **LOUD**

- ON: Select to boost base (100Hz) and treble (10kHz).
- OFF: Select for basic sound.

Note:

Too loud a volume could diminish the LOUD effect.
If LOUD is enabled, the LOUD or LD mark is displayed at the bottom of the screen and in the information display window.

● **BASS EX**

- ON: Select to boost bass (100Hz).
- OFF: Select for basic sound.

Note:

To reset to the factory settings, press the 'Default' icon.

CENTER/WOOFER

Set up the center and the woofer volumes of the 5.1 channel speaker.

- CENTER: Press the [+] or [-] icons to adjust the volume.
- WOOFER: Press the [+] or [-] icons to adjust the volume.

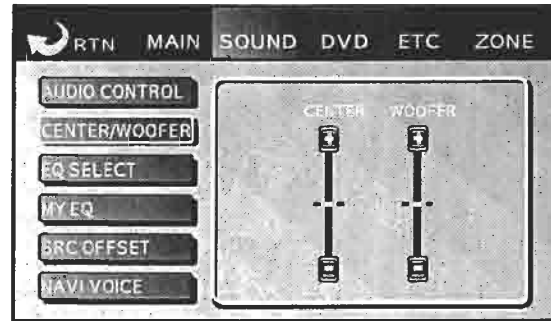

Note:

To reset to the factory settings, press the [Default] icon.

EQ SELECT

Set up EQ (Equalizer).

Note:

If you set up EQ, the EQ mark will be displayed at the bottom of the screen and in the information display window.

Three default settings are POP, CLASSIC, and ROCK. User-defined EQ settings may also be saved for three user modes.



Note:

For more information on user modes, see "MY EQ" on page 43.

- POP: EQ settings suitable for pop music.
- CLASSIC: EQ settings suitable for classic music.
- ROCK: EQ settings suitable for rock music.
- USER 1/2/3: EQ settings to user preference. Set up and save user-defined settings in 'MY EQ'.
- DEFEAT: Press if you don't want to use EQ, and the EQ mark will disappear from the bottom of the screen and the information display window.

MY EQ

Set up EQ to your preference.



Set value for each of three frequency regions: BASS, MID, and TRE. Each region can have 15 steps ranging from -7 to +7.

- BASS: Press the [BASS] icon, and then press the [▲] or [▼] icons to adjust value.
- MID: Press the [MID] icon, and then press the [▲] or [▼] icons to adjust value.
- TRE: Press the [TRE] icon, and then press the [▲] or [▼] icons to adjust value.

Once you finish setting, press ①, ② or ③ to save the settings to the selected number.

- ①: Select to save the settings to USER1 in [EQ SELECT].
- ②: Select to save the settings to USER2 in [EQ SELECT].
- ③: Select to save the settings to USER3 in [EQ SELECT].

SRC OFFSET

Sounds in different sources may have different volume level. Therefore, you can adjust the initial settings for each source to ensure an appropriate volume level when selecting a source. After each source is selected, press the SOUND or SETUP buttons to set the SRC OFFSET value in the SOUND setup screen. Sources available for set up are TV, DVD, CD, and NAVI.



- You can adjust SRC OFFSET settings only for the source selected immediately before entering the SRC OFFSET screen. For example, if you enter the SRC OFFSET screen while watching a DVD source, you can adjust the DVD source's OFFSET settings as shown in the screen above.
- OFFSET settings are adjustable by up to 7 steps up/down from the current volume.

Note:

- The frequency bands for BASS, MID, and TRE are as follows:
 BASS: 100 Hz
 MID: 1 KHz
 TRE: 10 KHz
- The saved EQ settings are now available in [EQ SELECT].

NAVI VOICE

The [NAVI VOICE] icon will be generated in the SOUND SETUP window only if a navigation system supported by this product is installed, and AV3 MODE in SETUP-ETC-EXTERN is set to NAVI ON.



• NAVI VOICE feature

- ON: Voice navigation information service is supported.
- OFF: Voice navigation information service is not supported.

Note:

- You can turn on or off the NAVI VOICE feature by pressing and holding the [NAVI] button on the monitor (only if a navigation system supplied by this product is installed).
- [V.NAVI] at the bottom of the LCD panel will be displayed only if a navigation system supported by this product is installed, and AV3 MODE in SETUP-ETC-EXTERN is set to NAVI ON, and NAVI VOICE to ON.

■ **DVD setup**

Press and hold the [SETUP] button on the main unit for one second or longer and then press the [DVD] tab.



Caution Before you can use the PREFERENCE menu, you must press the [STOP] button twice to stop the disc completely.

● **DVD menu**

- GENERAL: Set up general DVD settings.
- AUDIO: Set up DVD sound.
- VIDEO: Sets up DVD video.
- PREFERENCE: Set up DVD options.
- PASSWORD: Set up password.
- EXIT: Exit the setup.

Note:

To move the cursor in DVD setup, use the direction [▲/▼/◀/▶] icons on the LCD panel or the direction [▲/▼/◀/▶] buttons on the remote controller. To select the menu, press the [ENTER] icon on the LCD panel or the [ENT] button on the remote controller.



Caution You can change DVD settings only if DVD is selected as source and a DVD disc is placed in the unit.

General setup



Note:

To move the cursor in DVD setup, use the direction [▲/▼/◀/▶] icons on the LCD panel or the direction buttons on the remote controller. To select the menu, press the [ENTER] icon on the LCD panel or the [ENT] button on the remote controller.

● **TV Display**

Adjust the aspect ratio of the TV screen.

- NORMAL/PS: Select to display the full screen. In some cases, the left and right sides of the picture may be cut off from the screen.

- **NORMAL/NB:** Select to retain the original aspect ratio. In some cases, black stripes may appear on the top and bottom of the screen.
- **WIDE:** Select if you use a wide-format monitor.

Note:

If you use an external monitor for viewing, the same TV display setting will apply.

● **Angle Mark**

- **ON:** Select to display the camera angle information on the screen during disc playback.
- **OFF:** Select not to display the camera angle information on the screen during disc playback.

Note:

This feature applies only when using DVD CDs recorded with multi-angle views.

● **OSD Lang**

- **ENG:** English is selected as the OSD language for the DVD setup screen.
- **CHN:** Chinese is selected as the OSD language for the DVD setup screen.

Note:

The OSD language set here is applied to the DVD playback screen only, not to the main OSD of the product.

● **Captions**

- **ON:** Captions are displayed.
- **OFF:** Captions are not displayed.

Note:

This feature is applied to VCD only. For DVD, subtitles may be used instead.

● **Last Memory**

- **ON:** Select to remember where playback stopped. When playback resumes, it will start from where it left off.
- **OFF:** Select not to remember where playback stopped. When playback resumes, it will start from the beginning.

Audio setup



Note:

To move the cursor in DVD setup, use the direction [▲/▼/◀/▶] icons on the LCD panel or the direction buttons on the remote controller. To select the menu, press the [ENTER] icon on the panel or the [ENT] button on the remote controller.

● **Speaker Setup**

- Downmix

Set up when you listen to multi-channel audio as 2-channel audio.

- LT/RT: Multi-channel audio information output is combined.
- Stereo: Multi-channel audio information output is in stereo.
- V SURR: Multi-channel audio information output is in virtual surround.
- OFF: Downmix is disabled. The original multi-channel is used.

- Front Speaker

Set up output of the front speaker.

- Large: Set the front speaker to produce a large output.
- Small: Set the front speaker to produce a small output.

- Center Speaker

Set up output of the center speaker.

- Large: Set the center speaker to produce a large output.
- Small: Set the center speaker to produce a small output.
- Off: Set the center speaker to produce no output. Make sure that Off is selected if no center speaker is installed.

Note:

You can select the center speaker only if downmix is set to Off.



Caution

If you have set 5.1 channel and installed no center speaker, be sure to set it to Off. Otherwise, no sound can be produced.

- Rear Speaker

Set up output of the rear speaker.

- Large: Set the rear speaker to produce a large output.
- Small: Set the rear speaker to produce a small output.
- Off: Set the rear speaker to produce no output. Select if no rear speaker is installed.

Note:

You can select rear speaker only if downmix is set to Off.

- Subwoofer

• On: Set the subwoofer to produce output.

• Off: Set the subwoofer to produce no output. Select if there is no subwoofer installed.

● **SPDIF setup**

To play DVD audio with an external audio player that uses SPDIF, select SPDIF audio signal output.

- SPDIF Output

• SPDIF OFF: Select to suspend SPDIF audio signal output.

• SPDIF/RAW: Select for direct output of Dolby Digital or DTS bitstream. Select when the external audio player is enabled with Dolby Digital decoding.

• SPDIF/PCM: Select for output of decoded Dolby Digital or DTS bitstream. Select when the external audio player uses a 2-channel digital stereo amplifier. DVD video discs recorded

in Dolby Digital, MPEG1, or MPEG2 will be output in PCM 2-channel format.

- Manual: Select to set digital output manually.

Note:

CD, Dolby Digital, DTS, MPEG, and LPCM settings are activated only if SPDIF Output is set to "Manual".

- CD
Select for digital output of CD sound.
- Dolby Digital
Select for digital output of sound recorded in Dolby Digital.
- DTS
Select for digital output of sound recorded in DTS.
- MPEG
Select for digital output of sound recorded in MPEG.
- LPCM
Select for digital output of sound recorded in LPCM. Select either 48K or 96K bit rate.



Caution 96K should be used for the bit rate because audio output may not be produced properly with 48K.



Caution

- If CD, Dolby Digital, DTS, MPEG or LPCM is set to "Off" in SPD1, audio output may not be produced properly during disc playback.
- If SPDIF Output is set to SPDIF Off, audio output may not be produced during disc playback.

● **Dolby Digital Setup**

- Dual Mono

Select in which way to output Dolby Digital audio as mono sound.

- Stereo: Select for stereo output.
- L-Mono: Output only the left sound through the left/right speakers.
- R-Mono: Output only the right sound through the left/right speakers.
- Mix-Mono: Combine and output the left and right sounds through the left/right speakers.

● **Channel Delay**

Set delay time by channel according to the speaker type and location.

Select the speaker and delay time by pressing the up/down/left/right buttons, and then press the 'Enter' button to save the settings.

Note:

Set up methods vary depending on the types and the locations of the speakers installed.

● **Equalizer**

- EQ Type

Enjoy 3D surround sound during DVD playback.

Supported preset EQ modes are: Rock, Pop, Dance, Techno, Classic, and Soft.

- Bass Boost

Select to boost base sound.

- Super Bass

Select to boost super base sound.

- Treble Boost

Select to boost treble sound.

● **3D Processing**

- Reverb Mode

Select and enjoy the following reverb (sound field) effects: Concert, Living room, Hall, Bathroom, Cave, Arena, and Church.

DVD Video setup

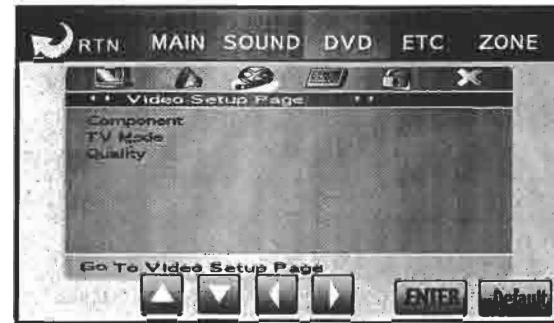

- **COMPONENT:** Sets up screen output. This setting is fixed to RGB in this product.
- **TV MODE:** Sets up display method. This setting is fixed to Interlace in this product.
- **Quality:** Sets up the following items that correct DVD source video signals.
 - Sharpness
 - Brightness
 - Contrast
 - Gamma
 - HEU
 - Saturation
 - Luma Delay

Preference setup



Caution Before you can use the preference menu, you must press the STOP button twice to stop the disc completely.

● **TV Type**

Set the DVD video output format.

- PAL
- NTSC

Note:

The screen may flash several times for a short period when the DVD video output format is changed.

● **PBC**

Select whether or not to use the PBC (Playback Control) menu during video CD playback.

Note:

Applicable only when VCD 2.0 is used.

● **Audio**

Set the audio language. If the disc is dubbed with multiple languages, the output audio will be in the selected language.

● **Subtitle**

Set the language for subtitles. If the disc that is being played has subtitles in the selected language, subtitles will be displayed in that language.

● **Disc Menu**

Set the language for the DVD disc menu.

● **Parental**

Limit viewing by rating. This feature is similar to movie ratings. The parental feature is available for DVD discs with ratings.

Note:

This feature is applied if a password is enabled.

● **Default**

Reset DVD settings to the factory settings.

Note:

The password settings, parental rating, and region code will remain unchanged.

Password

Password is used if Parental in Preference setup is enabled.



● **Password Mode**

Determine whether or not to use a password.



● **Password**

Set or change the password.



Enter the old 4-digit password in the Old Password text box.
Enter the new 4-digit password in the New Password text box.
Enter the new password again in the Confirm PWD text box. Once you finish entering your password, press the [OK] button.

Note:

If you forget your password, you may use the factory setting password, which is '1234.'

Exit DVD setup

To exit DVD setup, select the exit menu or press the [RTN] icon.



■ **Other Setup**

Press and hold the [SETUP] button on the main unit for one second or longer, and then press the [ETC] tab. The configuration screen

may look different depending on the model.

* Model that supports both TV and RDS



* Model that supports RDS, but not TV

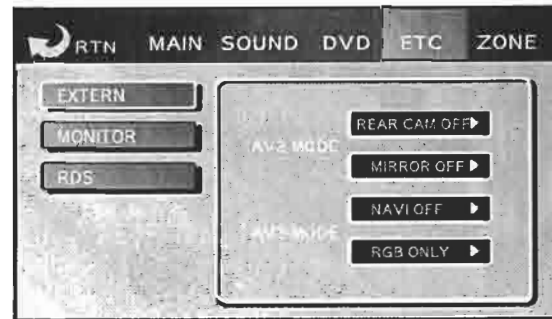

* Model that supports TV, but not RDS



* Model that supports neither TV nor RDS

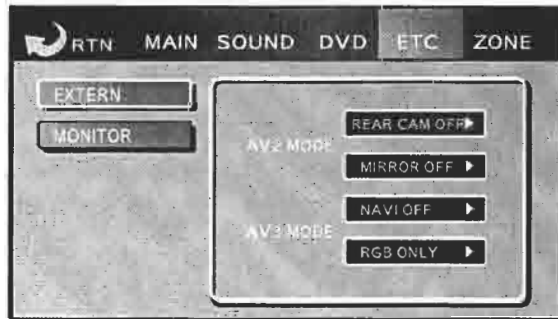

TV

Determine whether or not to select diversity antenna channel automatically.



- ON: The diversity antenna will automatically select the channel with the best reception out of four channels.
- OFF: Only the antenna connected to the no.1 antenna connector will be used.

Note:

This product can connect the diversity antenna to four channels. If this feature is set to On, the channel with the best reception will be automatically selected.

EXTERN

Select the type of external input.



● AV2 MODE

- REAR CAM ON: Set rear camera as external input. "CAM" will be displayed on the Extern screen.
- REAR CAM OFF: Set AV2 input as external input. "AV2" will be displayed on the Extern screen.
- MIRROR ON: Mirror images of AV2 or REAR CAM will be displayed
- MIRROR OFF: Original AV2 or REAR CAM images will be displayed.

● AV3 MODE

For information about NAVI installation, see "Installing Car Navigation" on page 58.

- NAVI ON: set as NAVI input. BAVD on the EXTERN screen displays NAVI.
- NAVI OFF: set as AV3 input. BAVD on the EXTERN screen displays AV3.

MONITOR

Select whether or not to retain the LCD panel's current position if the car engine stops.

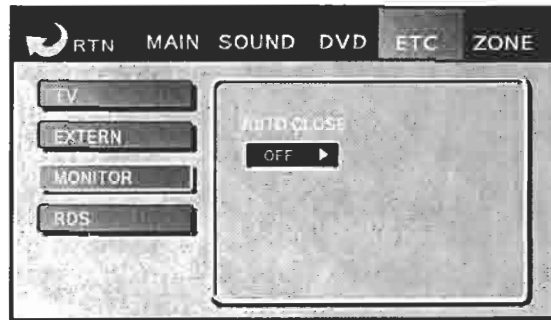

- ON: The LCD panel will be automatically closed if the car engine stops (if the key is in a position other than ACC).
- OFF: The LCD panel will retain the current position if the car engine stops (if the key is in a position other than ACC).

RDS

Set up RDS-related features.



● TA MODE

- TA SEEK: Automatically scan TP stations if the TA feature is enabled.
- TA ALARM: Alarm with beep and message if the selected station is a non-TP station.

● TA MINIMUM VOLUME

If you set the minimum level for audio volume, the driver can be alerted when traffic information is received. If the volume before traffic information is received is less than the minimum level set, the volume will be automatically increased to the minimum level. Once traffic information is received, the volume will return to the previous level.

■ ZONE setup

Press and hold the [SETUP] button on the main unit for one second or longer and then press the [ZONE] tab.

ZONE setup allows you to determine Extern output source.

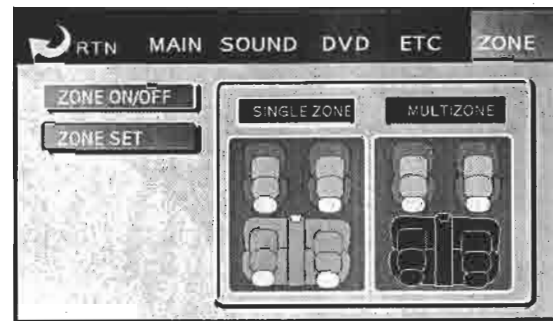

ZONE ON/OFF

- SINGLE ZONE: The 'front' source, i.e. the source you are currently viewing, is sent to external A/V output.
- MULTIZONE: The 'rear' source set in ZONE SET is sent to external A/V output.

ZONE SET

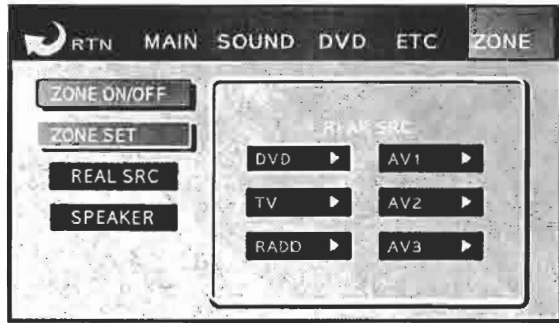

- REAR SRC: Determine external A/V output source.
- DVD: Set DVD as external output.
- TV: Set TV as external output.
- RADIO: Set RADIO as external output.
- AV1: Set AV1 as external output.
- AV2: Set AV2 as external output.
- AV3: Set AV3 as external output.

Note:

If you set ETC - EXTERN - AV3 MODE in SETUP to NAVI ON, the AV3 icon will be replaced by the NAVI icon as the external source.

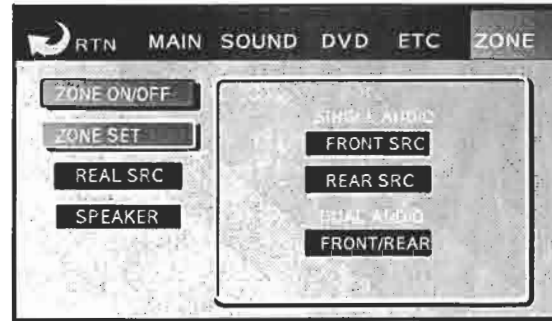

- SPEAKER: Set the audio output source that is produced by the speaker.
- FRONT SRC: Set the front/rear speakers to produce FRONT source audio.
- REAR SRC: Set the front/rear speakers to produce REAR source audio.
- FRONT/REAR: Set the front speaker to produce FRONT source audio, and the rear speaker REAR source audio.

■ Adjusting touch sensitivity of the LCD panel

Severe temperature fluctuations or environmental changes could cause the panel's touch sensitivity to change, preventing the icons on the panel from working. In this case you can adjust the touch sensitivity of the LCD panel to optimize it.

How to adjust touch sensitivity

1. Press and hold the [SETUP] button for one second or longer and then press the [ZONE] tab.
2. In the setup screen, press the [MENU] button for three seconds or longer to display the LCD panel adjustment screen.
3. Press 1st → 2nd → 3rd → 4th → 5th to display the [Return] icon at the bottom right of the screen.
4. Press the [Return] icon; the previous source screen will appear, and the LCD panel touch sensitivity adjustment will be completed.
5. Try pressing each icon to make sure it works well. If not, repeat the above procedures.

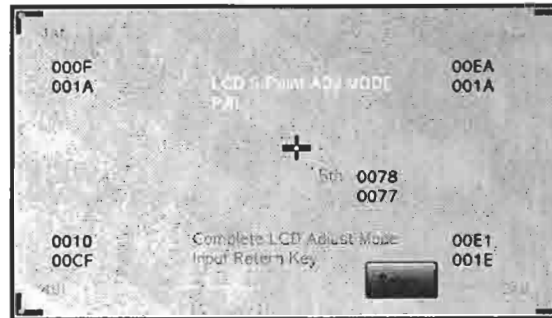

■ Installing CAR Navigation

To install a car navigation system in the Product, do the following:

- Model supported by the Product (FineMS NAVI system)
Use the dedicated 13-pin NAVI cable to connect the FineMS NAVI system to the Product.
For 13-pin interface specifications, see page 75.

* Connecting NAVI

Use the dedicated 13-pin NAVI cable to connect to a CAR navigation modules supported by the Product. The navigation system will be automatically detected once the Product is powered on.

* Connection Diagram

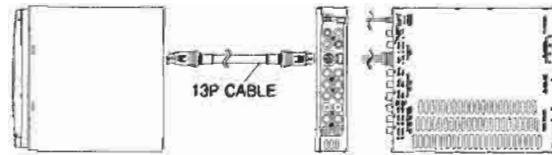

* Configuration Screen

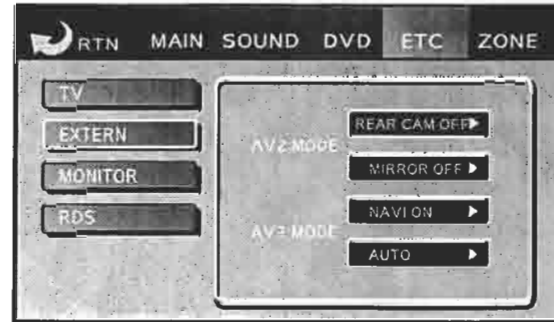

Caution  When you use a 13-pin cable not supported by the Product to connect a navigation system, see "Normal Navigation Systems" on page 59 before you start. Before you connect the Product to a navigation system, check the signal input conditions described in page 58-61. You cannot operate the navigation system through the Product's input unit. Using a navigation system system other than one that employs the dedicated 13-pin NAVI cable could cause the Product or the navigation system itself to fail. If either the system or the Product fails in this way, it is considered to be the responsibility of the user and not eligible for warranty.

● Normal Navigation Systems

The Product can use navigation systems (except for ones supported by the Product) that generate CVBS or RGB signal outputs.

1) Navigation systems that generate CVBS and AUDIO outputs
Connect mono audio and CVBS.

Connection Diagram

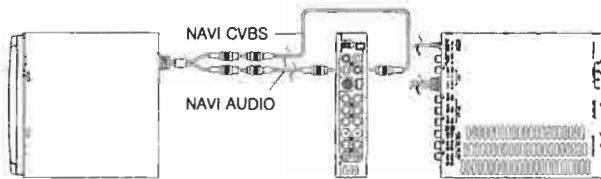

Configuration Screen

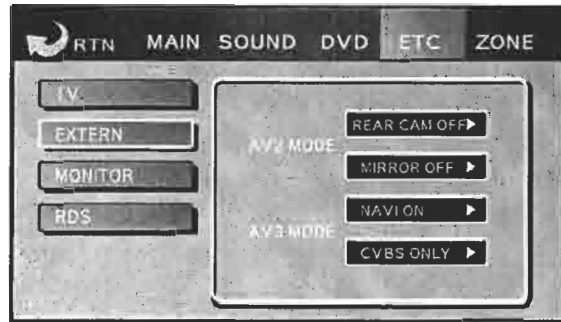

2) Navigation systems that generate RGB and AUDIO outputs

Connect mono audio and RGB. In this case, G signals must include SYNC.

Connection Diagram

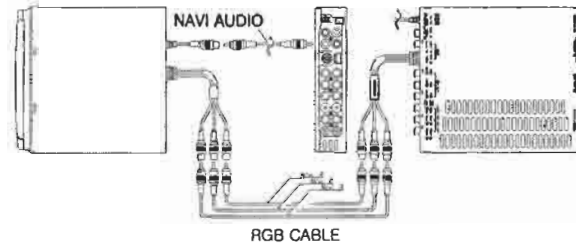

Configuration Screen

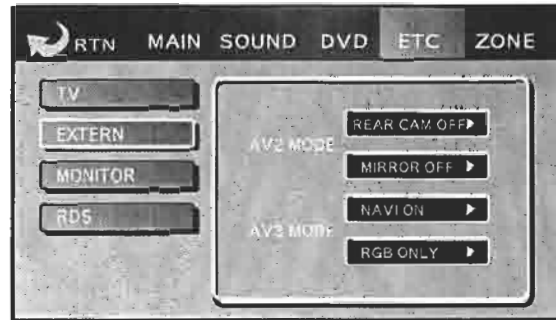

3) Navigation systems that generate RGB, CSYNC, and AUDIO outputs

Connect RGB, SYNC, and mono AUDIO.

Use when G signals do not include SYNC.

It can be used when G signals include SYNC, but in this case the NAVI screen will appear only when the screen is set to RGB ONLY mode, or RGB+CSYNC mode.

RGB + CSYNC mode has clearer picture quality.

Connection Diagram

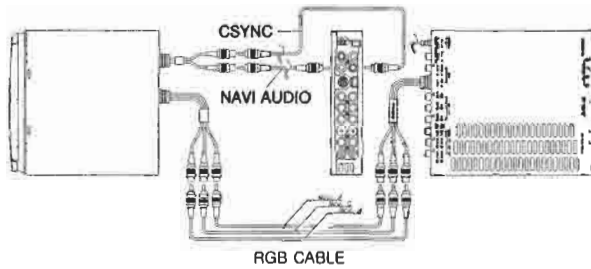

Configuration Screen



4) Navigation systems that generate RGB, CVBS, and AUDIO outputs

Connect RGB, CVBS, and mono AUDIO. Use when G signals do not include SYNC.

It can be used when G signals include SYNC, but in this case the NAVI screen will appear only when the screen is set to RGB ONLY mode, or RGB+CSYNC mode.

RGB + CVBS mode has clearer picture quality.

Connection Diagram

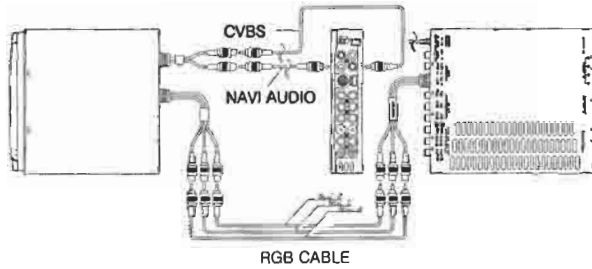

Configuration Screen



Note:

Navigation products supported by the Product are the following:
 Korea: NSS-350M
 U.S.A., Europe: NSS-350D

Appendix

■ DVD player error messages

Message	Description	Solution
Please Check Disc	The disc cannot be read.	Clean the disc or replace it with another one.
Err 0	The temperature of the DVD loader is 75 degrees Celsius or higher.	Power off the unit, and allow it to cool before using again.
Err 1	The temperature of the DVD loader is minus 30 degrees Celsius or lower.	Power off the unit, and warm it up before using again.
Err 5	The spindle motor does not work properly or at all.	Power off the unit, and power it back on. If the problem persists, contact the Service Center.
Tray Error	The disc is jammed in the tray: it can neither come out nor go in.	Power off the unit, and power it back on. Press and hold the [▲EJECT] button to force the disc to eject. If the problem persists, contact the Service Center.
⊘ Input Invalid	An incorrect button or icon has been pressed.	Press the correct button or icon.
⊘ Play Back Only	A playback command that is not supported in the current mode has been pressed.	Press the correct button or icon.

■ Troubleshooting

If you fail to solve problems with any of the following solutions, please contact our Service Center.

	Problem	Cause	Solution
General	Power does not turn on.	The lead or connector is connected incorrectly.	Connect the lead and the connector correctly.
		The fuse has blown.	After determining and removing the cause, replace the fuse with a new one of the same capacity.
	Power does turn on, but the unit does not work.	The operating environment is too cold or hot.	Operate the unit at room temperature.
	The buttons do not work, and the screen does not display correctly.	The microprocessor is malfunctioning due to noise or other causes.	Power off the unit and then power it back on. Or, switch off the car engine and then switch it back on.
	The touch-panel does not work correctly.	The touch screen is incorrectly aligned.	Press and hold the [MENU] button for 2 seconds or longer in the setup menu, and then follow the on-screen instructions to adjust the touch screen.

	Problem	Cause	Solution
General	The remote controller does not work.	The batteries are dead.	Replace the batteries of the remote controller.
		The remote controller has been used incorrectly.	Maintain the correct angle or distance between the unit and the remote controller. Make sure that there are no obstructions between the unit and the remote controller. Press the desired button properly.
Disc Operation	The disc does not play or skips, or generates noise.	The disc is inserted the wrong side up.	Insert the disc with the label up.
		The disc is dirty.	Clean the disc.
		The disc is badly scratched or bent.	Replace the disc with one in good condition.
		The disc has dew on it.	Dry the disc before using it.
The disc cannot be inserted.	There is already another disc in the unit.	Remove the existing disc before inserting a new one.	
	Something is stuck in the disc insertion slot.	Remove whatever is stuck in the disc insertion slot before inserting a disc.	

	Problem	Cause	Solution
	The disc cannot be ejected.	A communication error has occurred.	Press and hold the [▲EJECT] button for one second or longer to force the disc to eject.
Screen Display	The screen displays nothing.	It is set to monitor-off mode.	Press the [NAVI] button to disable monitor-off mode.
		The handbrake is not engaged.	To view the TV, DVD, or VCD screens, engage the handbrake while the car is stationary.
	The handbrake cable is disconnected.	Connect the unit's handbrake cable before engaging the handbrake.	
The screen looks dark.	The brightness setting is too low.	In screen settings in the main setup, adjust the BRIGHT value.	
	The temperature of the unit is too low.	Operate the unit again when at room temperature.	
Voice signal	No sound is heard.	The volume is set too low.	Turn up the volume.
		The speaker cable is not connected correctly.	Connect the speaker cable correctly.
		It is set to Mute mode.	Check to see if it is in Mute mode.



	Problem	Cause	Solution
Voice signal	No sound is heard from a specific speaker.	In the DVD settings, the speaker is set to OFF.	In the audio setup for DVD, change the setting to the appropriate value.
		The left/right BAL/FAD setting is incorrect.	Check the BAL/FAD setting in the audio setup.
		The center speaker setting is set to either SMALL or LARGE when there is no center speaker installed.	In the DVD speaker setup, set the center speaker to OFF.
	The front and rear speakers generate different sounds.	In the Zone setting, the front and rear speakers have different sources.	Change the Zone setting.
DVD	DVD does not play.	A DVD disc with a different region setting has been used.	Use DVD titles with the same region number as on the unit.
	Parental protection mode is displayed, and DVD does not play.	The parental protection mode is enabled.	Disable the parental protection mode or change the parental protection level.
	DVD pauses during playback.	It is a dual-layered disc.	It is normal for dual-layered discs to pause during playback and resume.

	Problem	Cause	Solution
MP3	MP3 files do not play.	The disc storage standard is incorrect.	Make sure that the disc has stored the MP3 files according to ISO9660 Level 1/Level 2 standards. Make sure that the files you want to play have .mp3 extensions.
TV	The TV picture quality is poor.	Reception is bad.	Move to another place or change orientation.
		The antenna is not properly connected.	Make sure that the antenna is connected correctly. For antennae with the booster feature, check that the boost power is connected correctly. If the diversity feature is set to OFF, change it to ON, and reestablish connection starting from Antenna 1.
	The TV screen displays overlapping pictures.	Reception is poor.	Move to another place or change orientation.
	The TV screen shows dots or stripes.	There is radio interference.	Move to another place.



■ Specifications

Monitor

Screen size: 7-inch wide format, 154.08mm (W) X 86.58mm (H)

Display method: TFT active matrix LCD

Pixel count: 336, 960 [1,440 (W) X 234 (H)]

Color system: NTSC, PAL, SECAM

DVD Driver

Playable discs: DVD-Video, DVD-Audio, CD-DA, MP3, Video CD

Frequency response: sampling frequency 96KHz: 20Hz ~ 44KHz

Distortion: 0.3% or less (1KHz)

Signal-to-noise ratio: 80dB (1KHz) or higher (IHF-A)

Digital output format: Dolby Digital/DTS/LPCM

FM Tuner

Receiving frequency range:

87.5 MHz ~ 108.0 MHz, 50 KHz Steps (Europe)

87.5 MHz ~ 108.0 MHz, 100 KHz Steps

(USA1, Latin America, Korea/Australia)

87.5 MHz ~ 107.9 MHz, 200 KHz Steps (USA2, USA3)

76.0 MHz ~ 90.0 MHz, 100 KHz Steps (Japan)

65.0 MHz ~ 74.0 MHz, 30 KHz Steps (OIRT)

Usable sensitivity: 12dB or lower

Stereo separation: 25dB(98.1MHz) or higher

Frequency response: 30Hz ~ 10KHz

AM Tuner

Receiving frequency range:

530 KHz ~ 1620 KHz, 10 KHz Steps (USA1, USA2)

530 KHz ~ 1710 KHz, 10 KHz Steps (USA3)

522 KHz ~ 1620 KHz, 9 KHz Steps (Europe)

522 KHz ~ 1629 KHz, 9 KHz Steps (Japan)

520 KHz ~ 1620 KHz, 5 KHz Steps (Latin America)

531 KHz ~ 1602 KHz, 9 KHz Steps (Korea/Australia)

Usable sensitivity: 33dB or lower

LW Tuner

Receiving frequency range:

144 KHz ~ 288 KHz, 1 KHz Steps (Europe)

Usable sensitivity: 33 dB or lower

TV Tuner

Color system: NTSC, PAL, SECAM

Receiving channels:

VHF2~13 Ch, UHF14~69 Ch, [PA2NF68X], NTSC-M

VHF1~20 Ch, UHF21~69 Ch, [PA2BF69X], PAL-B/G
(CCIR+ITALY)

VHF1~20 Ch, UHF21~69 Ch, [PA2MF70X], PAL-I/I (Ireland +
Great Britain)

VHF1~20 Ch, UHF21~69 Ch, [PA2MF70X], PAL-D/K (OIRT)

VHF1~12 Ch, UHF13~69 Ch, [PA2MF70X], PAL-D/K (China)

VHF1~19 Ch, UHF20~69 Ch, [PA2BF69X], PAL-B/B (Australia)

Antenna input: 75, 4-Ch Diversity



Audio Amp

Rated power output (10% output): 20W X 4 (1KHz, 4Ω)

Speaker Impedance: 4~8Ω

General

Power input voltage: 14.4V (10.5~16V allowable)

Current consumption: 4.0A (1W)

Operating temperatures: -15° C ~ +60° C

Storage temperatures: -30° C ~ +85° C

Size

Main unit: 178mm (W) X 50mm (H) X 198mm (D)

Tuner/Amp unit: 178mm (W) X 38.5mm (H) X 200mm (D)

Weight

Main unit: 2.4 Kg

Tuner/amplifier unit: 1.2 Kg

System Connection

■ Installation

⚠ Danger

- Information regarding the installation of this product is intended primarily for experienced installers. The company is not responsible for any problems caused by amateur installation.
- Wrap all the wires securely using wiring clamps or insulating tape.

⚠ Cautions

- Do not drill through the bulkhead between the engine and the interior to connect the product's yellow power cable to the car battery. Doing so could fray the cable's insulation, causing the product to malfunction or be damaged. The hole could also transmit exterior or engine noise to the interior.
- When installing the product's connection cables, be careful not to let them interfere with moving parts such as the gear shift, handbrake, or seat adjustment mechanism. The cables could obstruct normal driving, leading to accidents.
- Do not shorten the connection cables included in the product. Doing so could cause the product's protection circuit to malfunction.



- This product must be connected to a 12V DC battery with negative grounding.
- Before you connect this product to SUVs, trucks or buses, check their battery voltage. If the voltage is different, use a transformer (sold separately) to adjust the voltage before using the product.
- Before you connect the battery cable, be sure to power off the product. Failure to do so could cause an electric shock or short circuit.
- Do not install this product's connection cables near to a heater or other source of heat. Doing so could lead to loss of cable insulation, causing the product to malfunction or be damaged.
- Do not connect the power supply cable to any other equipment. Doing so could cause the current capacity of the connection cable to be exceeded, resulting in fire or damage to the unit.
- When replacing the fuse, be sure to use only fuses compliant with the standard marked on the fuse holder. Using any other fuse could cause the current capacity of the connection cable to be exceeded, resulting in fire or damage to the unit.
- When you connect speakers to this product, use only speakers of high power type. The impedance of such speakers is 4~8 Ω (ohms), and the minimum rating output is 50 W or higher. If you connect speakers with an output or impedance other than the indicated values, the product or the speakers could be damaged.
- Be careful not to connect the blue lead of the product to the power terminal of the automatic antenna. This could cause the product to malfunction or be damaged.
- Be careful not to connect the blue/white lead of the product to the power terminal of the external power amplifier. This could cause loss of current and malfunction.
- Be sure to bind exposed cables with insulating tape. In particular, insulate the connection cables of speakers that are not in use. Connection cables that are not insulated could cause electric shock or short circuit.
- This product cannot be installed in a vehicle whose ignition switch has no ACC ON position.
- When using the ground cable (black lead), separate it from other units that consume high current, such as the power amp. Failure to do so could cause fire or damage to the product.

Components

① Main unit 1 EA



② Tuner/Amp unit 1 EA

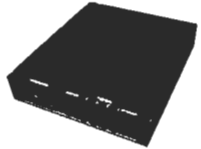

③ Power cable (18pin/2pin)
1 EA



④ 13 pin link cable 1 EA



⑤ 8 pin link cable 1 EA



⑥ Antenna extensions (3m)
2 EA



⑦ Universal mounting bracket
1 EA



⑧ Trim cover 1 EA



⑨ Split bars 2EA



⑩ Rear support strap 1 EA



⑪ Remote controller
1 EA



⑫ Mounting brackets 2 EA



⑬ Double-sided tape 2 EA



⑭ Batteries (AAA) 2 EA



⑮ User's manual 1 EA



⑯ Mounting screw (M5x6)
1 EA



⑰ Self-tapping screws
(TAP5x16)
5 EA



⑱ Machine screws (M4x4)
4 EA



⑲ Machine screws for main unit
(M5x6)
6 EA



⑳ Machine screws for main
unit (M4x3)
4 EA



Installing the main unit

(Method 1) Installation using the universal mounting bracket

1. Insert the universal mounting bracket into the vehicle's instrument panel.
2. Use a screw driver to bend all the universal mounting lugs inwards. (There are five lugs each on the top and bottom of the universal mounting.)



Caution

Fix the main unit so that it cannot come loose or vibrate.

3. Insert the main unit into the universal mounting bracket until it is secured.
4. Refer to "System Connection" on page 72 and "Power Connection" on page 73 to install the connection cables.
5. Install the trim cover. Make sure that all the hooks are secured.

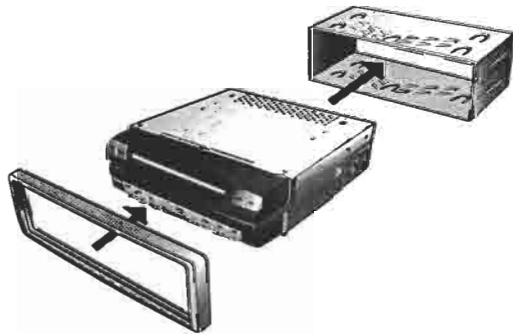

(Method 2) Installation using the rear support strap

1. Fix one end of the rear support strap to the rear of the main unit where the universal mounting bracket is installed.
2. Fix the other end of the rear support strap.

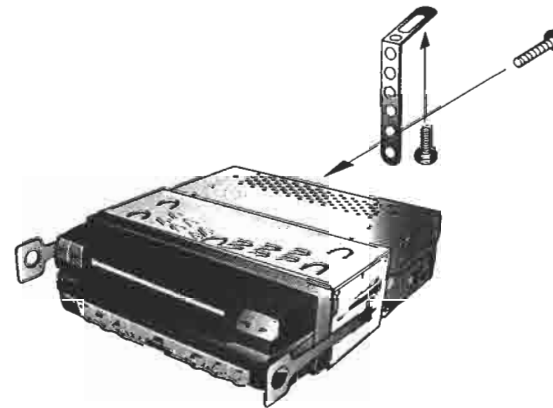

Installing the tuner/amp unit

(Method 1) Installation using brackets

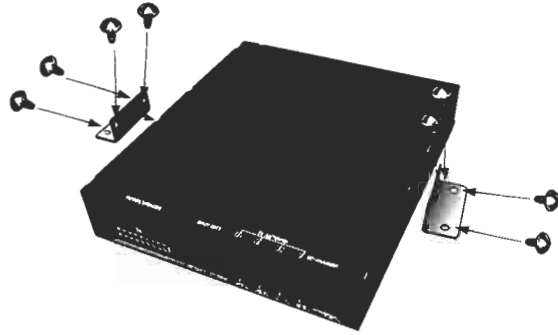

1. Use the screws (M4X4 (19)) to fix the included mounting brackets (12) on the tuner/amp unit.
2. Drill holes with a diameter of 3.5 mm, aligning them with the bracket holes.
3. Use the self-tapping screws (17) to fix the tuner/amp unit to the floor.

(Method 2) Installation using velcro

1. Stick the velcro tapes supplied to the bottom of the tuner/amp unit.
2. Fix the tuner/amp unit under the seat.

Note:

Installation using velcro may not be possible on some car carpets.

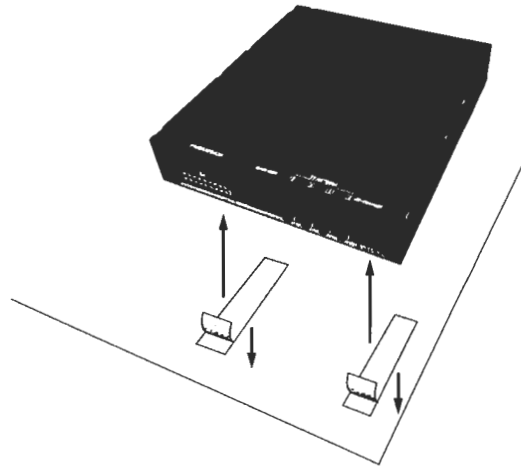

Removing the main unit

1. Unscrew the rear of the main unit by following the instructions for "Installing the main unit" on page 69 in the reverse order.
2. Remove the trim cover.
3. Insert the split bar between the spring and the universal mounting bracket.
4. Use the split bar to remove the main unit.

 **Caution** Keep the split bar in a safe place. The main unit cannot be removed without it.

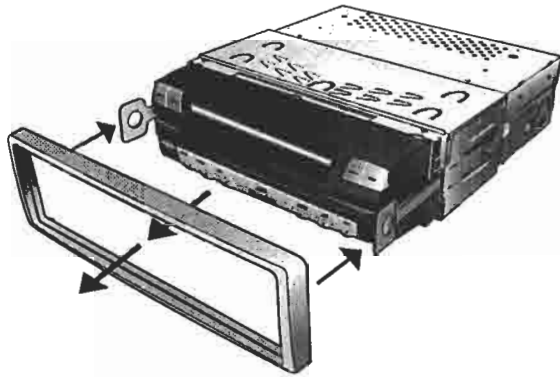

■ System Connection

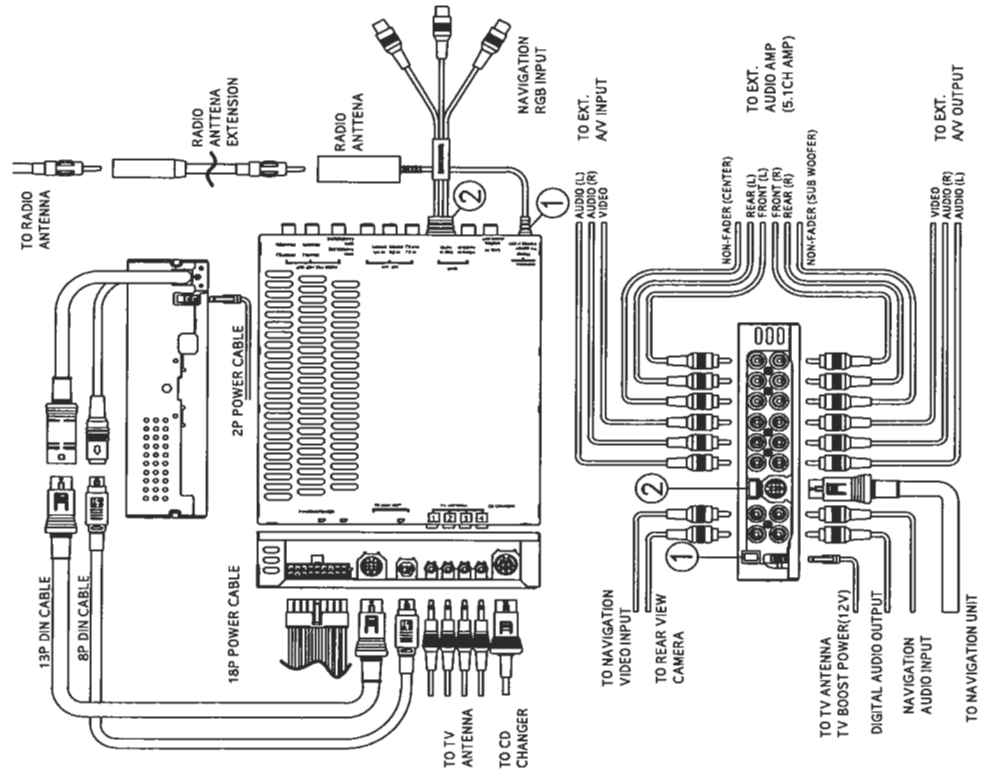

■ Power Connection

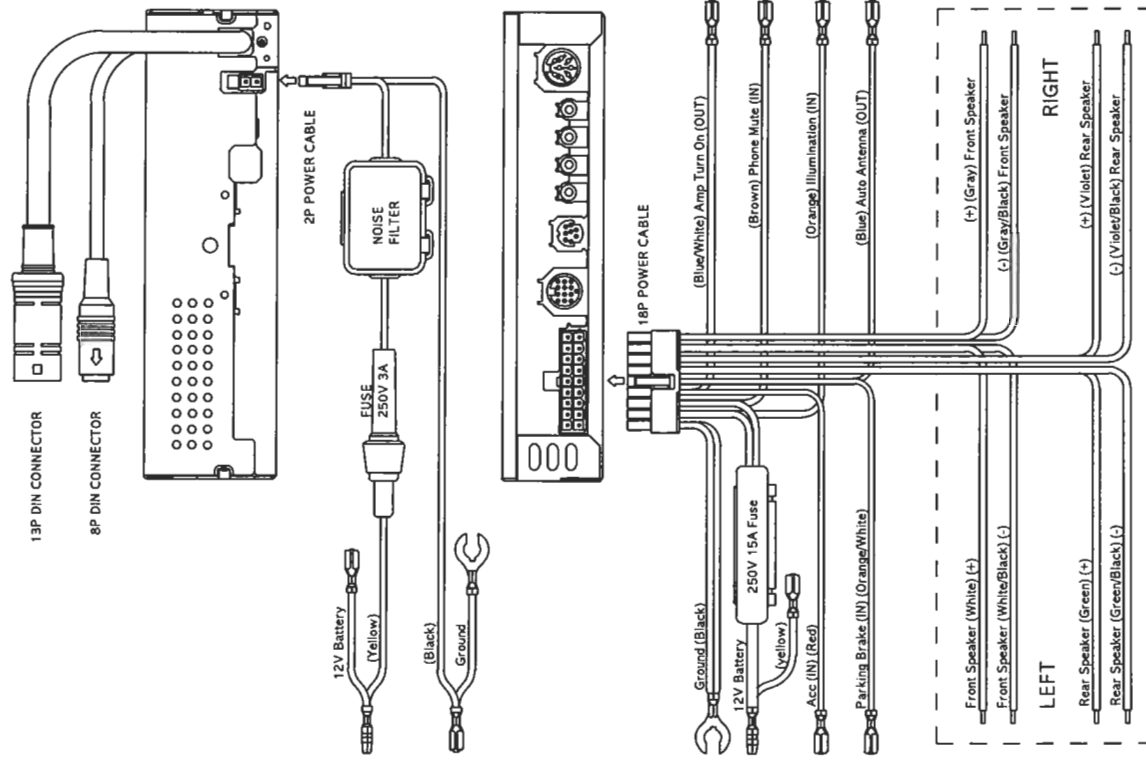

■ PTY List

NO.	PTY Name	Description
1	News	News
2	Affairs	Current Affairs
3	Info	Information
4	Sports	Sports
5	Educate	Education
6	Drama	Drama
7	Culture	Culture
8	Science	Science
9	Varied	Varied
10	Pop M	Pop Music
11	Rock M	Rock Music
12	Easy M	Easy Listening Music
13	Light M	Light Classical
14	Classics	Serious Classics
15	Other M	Other Music

NO.	PTY Name	Description
16	Weather	Weather
17	Finance	Finance
18	Children	Children' s Programs
19	Social	Social Affairs
20	Religion	Religion
21	Phone In	Phone In
22	Travel	Travel
23	Leisure	Leisure
24	Jazz	Jazz Music
25	Country	Country Music
26	National	National Music
27	Oldies	Oldies Music
28	Folk M	Folk Music
29	Document	Documentary

■ H/W I/F Specifications of Car Navigation Supported by the Product

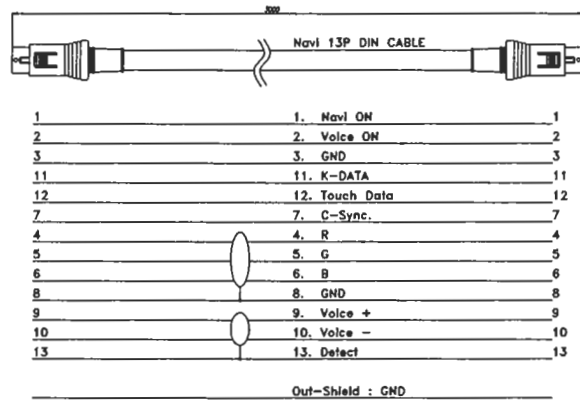

Socket Front View



NO.	FineMS	Specification NAVI(1/26/05)	Direction
1	NAVI ON	DC +5V Power detect	Out
2	VOICE ON	Mute signal (+5V : ative, 0V : Mute)	Out
3	GND	Ground	
4	Red Out	75Ω, 0.7Vp-p	Out
5	Green Out	75Ω, 0.7Vp-p	Out
6	Blue Out	75Ω, 0.7Vp-p	Out
7	CSYNC	TTL level	Out
8	VGND	Video Ground	Out
9	Audio Out-L	500 mVrms (Load 47KΩ,1Khz)	Out
10	Audio Out-R	500 mVrms (Load 47KΩ,1Khz)	Out
11	KDATA (Remocon Signal by-pass)	TTL level	In
12	Touch Data(Rx, UART)	TTL level	In
13	Detect(GND)	Ground	Out